

Operators and Technicians Manual

PSA-66-ST2 Printer

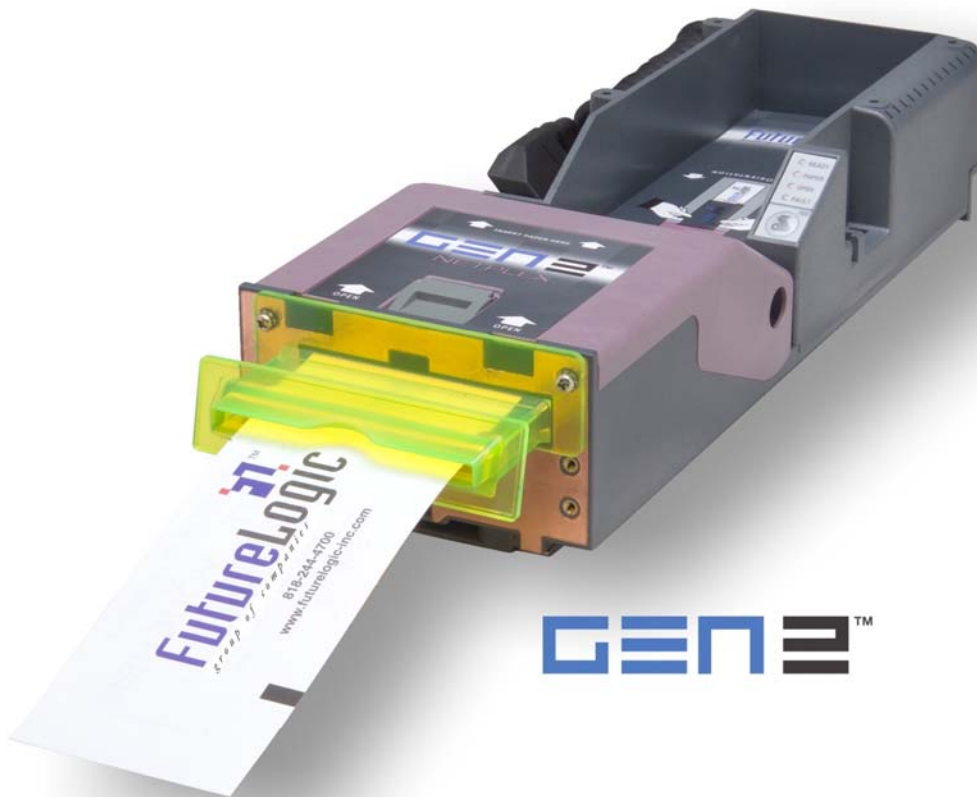

PSA-66-ST2R (RS232); PSA-66-ST2N (Netplex)

While PSA-66-ST2 refers to both the PSA-66-ST2R and PSA-66-ST2N versions of the printer, this manual is written primarily for the RS232 interface. For additional information on the Netplex interface, please contact International Game Technology.

Operators and Technicians Manual

PSA-66-ST2 Printer (GEN2™)

© 2002 – 2007 FutureLogic, Incorporated. All Rights Reserved.

TCL Printer Language © 1991 – 2007 FutureLogic, Incorporated. All Rights Reserved.

TCL Printer Language is a proprietary, copyrighted language developed by FutureLogic, Incorporated for exclusive use with its printer products.

GEN2 Powered by FutureLogic, GEN2, TCL, ITH, TRT, TCL Editor, Download Utility, CommWrangler, FutureLogic Exchange, and FutureLogic are either trademarks or registered trademarks of FutureLogic, Incorporated in the United States and/or other countries.

Netplex is a proprietary hardware interface and protocol of International Game Technology Corporation.

Molex is a registered trademark of Molex Incorporated. All product names referenced herein are trademarks of Molex, its affiliates, related companies, licensors, and/or joint venture partners.

All other trademarks and products or brand names mentioned herein are the property of their respective owners.

This document contains Proprietary and Confidential information and its contents are covered by Non-Disclosure Agreement.

Technical information in this manual is disclosed for informational purposes only.

No grant of license or use rights of any such information is made by publication or distribution of this manual.

No part of this guide may be reproduced, stored in a retrieval system, or transmitted, in any form or by any means, electronic, mechanical, recording, or otherwise, without the prior written permission of FutureLogic, Incorporated.

These specifications are subject to change without notice and may not completely and correctly document the operation of this product.

12/07/2007

MNL-000003

REV.N



The GEN2 Netplex printer (PSA-66-ST2N) is in compliance with the Netplex protocol of IGT.
The PSA-66-ST2 printer described in this manual is in compliance with all applied CE standards.

This document describes product functions and technology that may not be available in a particular gaming jurisdiction, and would therefore not be available for sale and not approved for use at this time. Please contact your local sales representative for information concerning what features are available in your jurisdiction.

Table of Contents

1	Product Overview	1
	Introduction	1
	Warranty Information.....	1
2	Operator Interface.....	2
	Introduction	2
	Operator Indicators and Controls	2
	Keypad Status Light	3
	Bezel Operation	3
	Printer Sensor Functions.....	3
	Printer Errors.....	4
	Loading Paper	5
	Feeding Paper	5
	Performing a Self Test	6
	Clearing a Paper Jam	6
	Cleaning the Print Head	7
3	Printer Service	8
	Introduction	8
	Removing the Printer.....	9
4	Ports and Dip Switches	11
	Introduction	11
	Front Bezel Port (All Models).....	11
	PSA-66-ST2N (GEN2 Netplex Printer)	12
	GEN2 Netplex Interface Cable.....	12
	GEN2 Netplex Firmware Upload Port	14
	GEN2 Netplex Dip Switches	15
	PSA-66-ST2R (GEN2 RS232 Printer).....	16
	GEN2 RS232 Interface Cable – 12 Pin Coiled Cable	16
	GEN2 RS232 Interface Cable – 14 Pin Coiled Cable	18
	GEN2 RS232 Adapter Cable – 12 Pin to 14 Pin	19
	GEN2 RS232 Evaluation Cable	20
	GEN2 RS232 Firmware Upload Port	21
	GEN2 RS232 Dip Switches	23
	Appendix A Technical Specifications	24
	Appendix B Paper Specifications	26
	Appendix C Part Numbers – Printer/Spares	27
	Appendix D Part Numbers – Bezels	32
	Appendix E Schematics.....	34
	Working on the PCBA.....	34
	Appendix F Service Tool Kit	44
	Index	45

List of Figures

Figure 2-1	Operator Indicators and Controls	2
Figure 2-2	Load a Paper Stack	5
Figure 2-3	Feed Paper into Paper Loading Slot	5
Figure 2-4	Sample Configuration Ticket	6
Figure 2-5	Remove the Paper.....	7
Figure 2-6	Open the Lid	7
Figure 2-7	Clear the Paper Jam.....	7
Figure 3-1	Ground Screw and Copper Grounding Clips Location.....	8
Figure 3-2	Disconnect the Coiled Cable Connector	9
Figure 3-3	Slide the Printer until It Locks.....	9
Figure 3-4	Remove the Paper.....	10
Figure 3-5	Front Locking Bar	10
Figure 3-6	Push Release Bar	10
Figure 4-1	Front Bezel LED Control Port (All Models)	11
Figure 4-2	Netplex Interface Cable	12
Figure 4-3	Netplex Firmware Upload Port.....	14
Figure 4-4	Upload Cable Diagram	14
Figure 4-5	Netplex Dip Switches – Top View	15
Figure 4-6	RS232 Interface Cable, 12 Pin Coiled	16
Figure 4-7	RS232 Interface Cable, 14 Pin Coiled	18
Figure 4-8	RS232 Adapter Cable	19
Figure 4-9	RS232 Evaluation Cable.....	20
Figure 4-10	RS232 Firmware Upload Port	22
Figure 4-11	Upload Cable Diagram	22
Figure 4-12	Dip Switches – Top View.....	23
Figure B-1	Ticket Dimensional Specification	26

List of Tables

Table 2-1	Keypad LEDs Status Reporting Printer Condition.....	3
Table 2-2	Bezel Display Status	3
Table 2-3	Sensors	3
Table 2-4	Errors and Error Descriptions	4
Table 4-1	Front Bezel LED Control Port Pins (All Models).....	11
Table 4-2	Bezel LED Port Pins.....	12
Table 4-3	Auxiliary COMM Port Pin-out	12
Table 4-4	Netplex Power/COMM Port Pin-out	13
Table 4-5	12 Pin Netplex Base Port Pins	13
Table 4-6	Firmware Upload Port Pin-out	14
Table 4-7	Netplex 6 Position Dip Switch Settings	15
Table 4-8	Auxiliary COMM Port Pin-out	16
Table 4-9	Bezel LED Port Pins.....	16
Table 4-10	RS232 Power/COMM Port Pin-out.....	17
Table 4-11	12 Pin RS232 Base Port Pins.....	17
Table 4-12	Auxiliary COMM Port Pin-out	18
Table 4-13	RS232 Power/COMM Port 14 Pin-out.....	18
Table 4-14	RS232 Adapter Cable Pin-outs	19
Table 4-15	Bezel Port Pins	20
Table 4-16	12 pin Base Port Pins	21
Table 4-17	14 pin Base Port Pins	21
Table 4-18	DB9 RS232 Port Pins	21
Table 4-19	Firmware Upload Port Pin-out	22
Table 4-20	RS232 6 Position Dip Switch Settings	23

1 Product Overview

Introduction

Each GEN2™ printer is an advanced thermal printer capable of creating high quality complex output with a minimum of development and effort on the part of the user. The printer module supports both serial and a Netplex current loop interface to allow operation in any standard slot machine on the market.



Note: While PSA-66-ST2 refers to both the PSA-66-ST2R and PSA-66-ST2N versions of the printer, this manual is written primarily for the RS232 interface. For additional information on the Netplex interface, please contact International Game Technology.

Features of the GEN2 printer include:

- The ITH™ (Intelligent Ticket Handling) technology which prevents player interference with any part of ticket production or presentation
- May be mounted on an angle or horizontally
- Simple paper loading—no loose parts
- Variable paper capacity with different paper trays—300, 600, and 900 ticket trays
- Windows® ticket/receipt development package via the TCL™ Editor utility
- Page mode printing with TCL printer language
- Line printer capability
- High quality laser-like san serif fonts in multiple sizes
- Advanced graphics printing
- Windows connectivity
- 3 inch per second print speed
- Wide temperature range operation
- Standard and customized serial interfaces available—RS232 and Netplex

Warranty Information

Each GEN2 printer has a two-year warranty as per the manufacturer's written warranty on the printer.

2 Operator Interface

Introduction

This chapter covers various operations of the GEN2 printer including loading paper and clearing a paper jam.

Operator Indicators and Controls

The printer is equipped with status indicators and a FEED button, which allow you to manage and interpret the operations of the printer.

The status indicators are:

- The front bezel light
- Keypad lights:
 - Ready – Green
 - Paper – Yellow
 - Open – Orange
 - Fault – Red

The following figure illustrates the location of these indicators and controls.

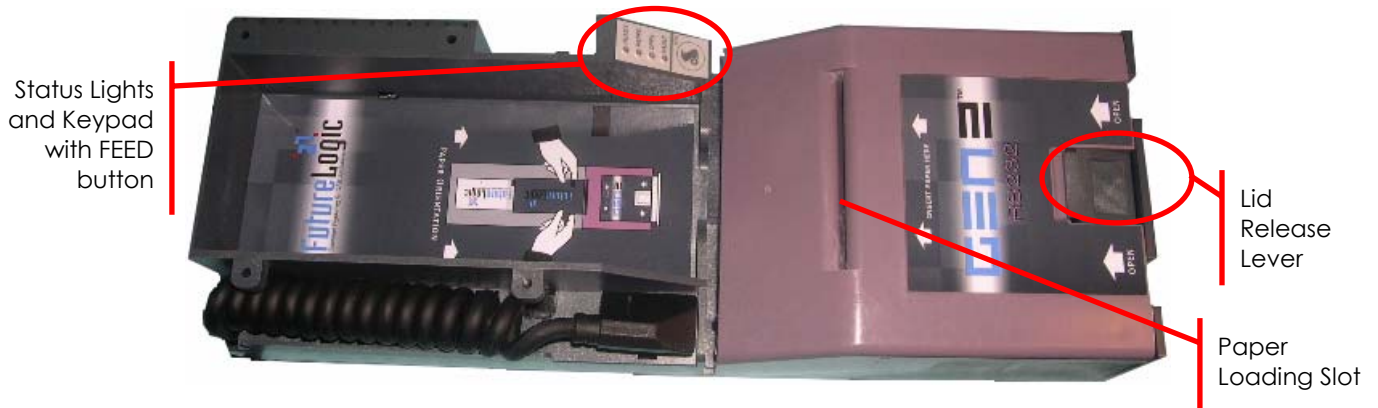



Figure 2-1 Operator Indicators and Controls

Keypad Status Light

The keypad LEDs report the status of the printer whenever power is present. Table 2-1 lists each condition of the keypad LEDs.

Table 2-1 Keypad LEDs Status Reporting Printer Condition

Condition	Ready	Paper	Open	Fault
Printer is Powered Off				
Printer Ready	blink			
Printer Flushed				
Paper Out				
Head Up or Ticket Module Open				
Temperature Error				
Voltage Error				
Print Head Error				
Missing Black Index Mark				
Paper is Jammed				blink

 Indicates the LED is ON.

Bezel Operation

Use the front bezel display to determine the state of the printer while on the casino floor, at a distance, without disturbing the game. Table 2-2 lists the conditions indicated on the bezel display.

Table 2-2 Bezel Display Status

Bezel Display	Status
Solid On	Printer Idle and Ready
Slow Blink	Paper Low or Printer Error
Fast Blink	Ticket Printing and/or Ticket in Chute
Off	Printer power off

See Chapter 4 for information on the current ratings of the bezel ports.

Printer Sensor Functions

There are six primary sensor functions on the printer. These sensors work with the game firmware to provide reliable trouble-free operation. Any error conditions resulting from these sensors are indicated by the front bezel light and keypad LEDs.

Table 2-3 describes each of these sensors.

Table 2-3 Sensors

Sensor	Description
Paper Out	The Paper Out sensor is located in the print head. It terminates the print operation when the paper has run out and checks for proper form registration. The printer ceases printing and feeding operations when it detects a Paper Out condition. Correct a Paper Out condition by loading more paper into the unit.
Paper Low	The Paper Low sensor is located in the paper well. It determines when the paper stack has approximately 14 tickets remaining. The paper_low status reports a paper low condition after the unit has printed out 10 more print jobs. The true condition of the paper_low status can be check by recycle the power. A Paper Low condition automatically resets once a stack with a greater height is loaded. Paper low sensing occurs when the system is idle and takes a few seconds to detect the new paper level.
Paper Taken	The Paper Taken sensor is located in the presentation chute of the printer. It determines when the customer has actually taken their cashout ticket.

Sensor	Description
Drawer Open	The Drawer Open sensor is located in the paper well. It detects when the printer is open.
Platen Engaged	The Platen Engaged sensor is located in the print head. It detects when the printer platen is in use.
Printer Open	The Printer Open sensor is located in the front of the unit. It detects when the printer clamshell is open.

Printer Errors

Although there are a variety of error conditions that can occur, most printer errors are a result of the printer running out of paper or the operator opening the lid. Table 2-4 lists possible errors and the remedy for each condition.

Table 2-4 Errors and Error Descriptions

Error	Error Description	Remedy
Paper Out	Results when the printer does not detect paper present.	Load a new paper stack.
Head Up or Open	Results from raising the head release lever or opening the lid.	Lower the blue lever on the side of the unit.
Temperature	Results when the printer is operating outside of its allowable temperature range. If the printer is operating in an environment where the ambient temperature is roughly room temperature, this error would most likely be the result of a hardware problem.	The printer will automatically resume operation after the detected head temperature falls within range.
Voltage	Results if the printer detects a power supply voltage (+24VDC to +25VDC) outside range. This error could be the result of a poor cable connection.	The printer will automatically resume operation after the power supply is detected within range.
Print Head	Results when the printer senses an internal error due to connectivity or interfacing problem with the thermal print head. This can be a result of a cable problem between the main controller board and the printer engine.	The printer will remain in this error state until the power is cycled or the unit is reset. If the problem persists, the printer will require service.
Missing Black Index Mark	Results if the paper type selected is indexed paper and while feeding paper or printing a black mark is not seen within approximately 10" of the paper. This error alerts the user to the presence of the wrong kind of paper in the printer or that the paper was inserted in the wrong direction (so the black mark index is rotated 180 degrees).	Raise the head release lever (presumably to change the paper).
Paper Jam	Results when the printer detects an error in the paper path for presenting the ticket to the customer.	Open the printer head and inspect for a jammed ticket.

Loading Paper

Generally, the only printer service required is to load new paper stacks. Use the automatic paper-loading feature to simplify this process to two steps: putting the paper stack into the Paper Tray and feeding the paper to the Paper Loading Slot of the printer.

To load paper:

1. Pull open the Printer Drawer until the Paper Tray is completely accessible.
2. Place the paper stack in the printer as indicated by the band around the stack and the label on the bottom of the Paper Tray.



Tip: To prevent a new paper stack from sticking together, fan out the paper after you take off the band.



Figure 2-2 Load a Paper Stack

3. Feed the paper into the Paper Loading Slot and release it once the motor engages and the printer takes hold of the paper.

The printer automatically pulls through a form or two, leaving it registered at the top of a form.



Figure 2-3 Feed Paper into Paper Loading Slot

4. Remove any excess ticket from the printer.

Feeding Paper

The printer is designed to run with black mark indexed paper.

Use the FEED button to feed paper into printer. Press the FEED button to advance the paper to the top of the next form.

Performing a Self Test

Press the FEED button during power up or reset to run a self test. This self test prints a configuration ticket if the test passes successfully. The test ticket (illustrated in Figure 2-4) contains important information on how the unit is configured.

Model number	Model: PSA-66-ST2	Resident ticket template package version
	Firmware: GRUSA4100 TKT-2.3	
	COMMUNICATION	
System communications setup	Interface: serial	Firmware version
	Baud Rate: 19200	
	Data Bits: 8	
	Parity: NONE	
	Handshaking: XON/XOFF/HARDWARE	
	PRINT CONTROL	
Print Control Parameters	Darkness Control: +00%	
	Black Bar Index: Enabled	
	Print On Demand: Disabled	
	Auto Sleep Timer: Off	
	SYSTEM RESOURCES	
	FLASH -Used: 000000	Amount of memory available for user-defined font and graphics storage is indicated by the "Free" space.
	-Free: 024064	
	LIBRARY INVENTORY	
Listing of stored Templates, Print Regions and Graphics	Templates: 0,1,2,3,4,5,6,7,8,9,A,B	
	Print Regions: 1,2,3,4,5,6,7,8,h,9,A,B	
	C,D,E,F,G,I,J,K,L,N,O,P,	
	Q,R,S,T,U,Z,X,a,b,c,d,e,	
	f,g,i,j,k,l,m,n,o,p,q	
	Graphics: E,F,G,H,I,J,K,L,M,N,O,P	List of fonts available in the printer by TCL page mode
	Fonts: 3,1,2,4,7,8,5	

Figure 2-4 Sample Configuration Ticket

Clearing a Paper Jam

The printer is designed to operate reliably with minimal paper jamming. If you need to clear a paper jam, follow the instructions below. After you clear a paper jam, perform these steps in reverse to load paper.

When clearing a paper jam:

- Ensure that all paper paths from the entry point at the back of the paper well, through the printer, cutter, and the ticket module chute are clear of paper or obstructions.
- Use the Lid Release Lever located on the top of the unit.
- Do not allow a screwdriver or other probing object to come in contact with the printer. This can cause permanent damage to the printer.

To clear a paper jam:

1. Remove the paper from the printer.



Figure 2-5 Remove the Paper

2. Open the lid by pressing the Lid Release Lever.
The spring-loaded lid opens, exposing the paper path.

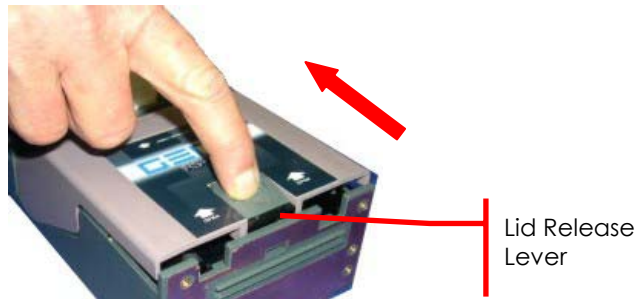

Figure 2-6 Open the Lid

3. Remove the jammed ticket.
If necessary, access the paper path through the print mechanism by opening the Mechanism Release Lever.



Figure 2-7 Clear the Paper Jam

4. Once you clear the jam, reverse these steps to return the printer to a ready state.
5. Load the paper.

Cleaning the Print Head

To clean the print head, use canned air to blow out the paper particles. Then use a lint-free cloth or cotton swab with isopropyl alcohol to clean the print head.

3 Printer Service

Introduction

This chapter provides instructions on how to remove the printer to service it outside of the game.



Note: While the printer is hot-connectable, it is still a good maintenance procedure to turn off the power.



Important Information!

Do not remove the ground screw in the rail as it will release the internal nut!
After removing the printer, do not slide the unit on a tabletop or other surface. Doing so will cause damage to the copper grounding clips on the bottom of the unit.

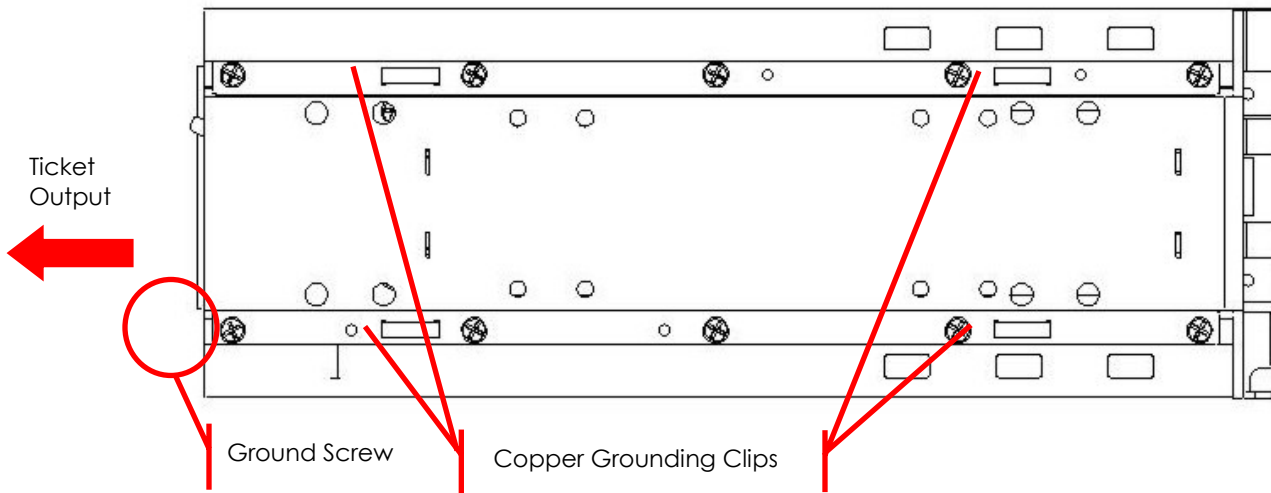

Figure 3-1 Ground Screw and Copper Grounding Clips Location

Removing the Printer



CAUTION!

ESD Sensitive Equipment!

Electronic boards and their components are sensitive to static electricity. Care must be taken during all handling operations and inspections of this product in order to ensure product integrity at all times.

Do not handle this product out of its protective enclosure while it is not used for operations purposes unless it is otherwise protected.

Discharge your clothing before touching the assembly. Discharge tools before use.

Whenever possible, unpack or pack this product only at EOS/ESD safe workstations. Where a safe workstation is not guaranteed, it is important for the user to be electrically discharged before touching the product with his/her hands or tools.

To remove the printer from the game:

1. Disconnect the power.
2. Disconnect the Coiled Cable Connector.



CAUTION! The cable is under tension.

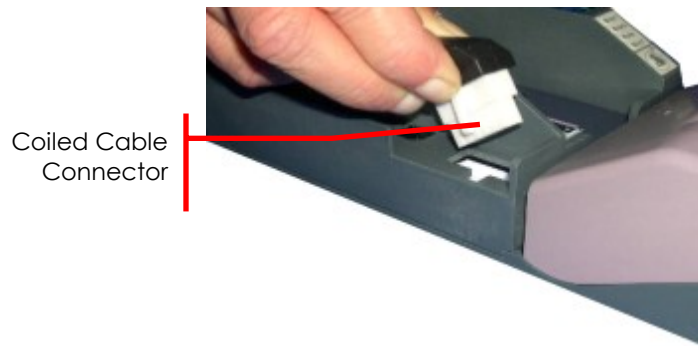

Figure 3-2 Disconnect the Coiled Cable Connector

3. Pull the printer out of the game until it locks.



Figure 3-3 Slide the Printer until It Locks

4. Remove the paper from the printer.



Figure 3-4 Remove the Paper

5. Push the Front Locking Bar unit to unlock the sliding module from stationary module. Slide the drawer module completely out of the stationary module.

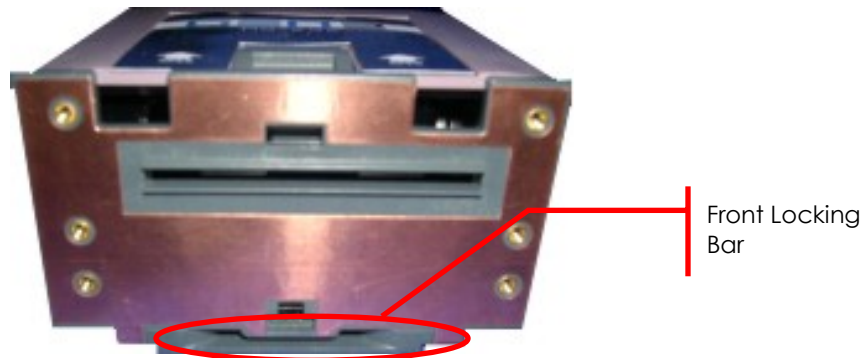

Figure 3-5 Front Locking Bar

6. Push the Release Bar (located on the bottom of the unit). While holding in the Release Bar, gently pull the printer towards you.

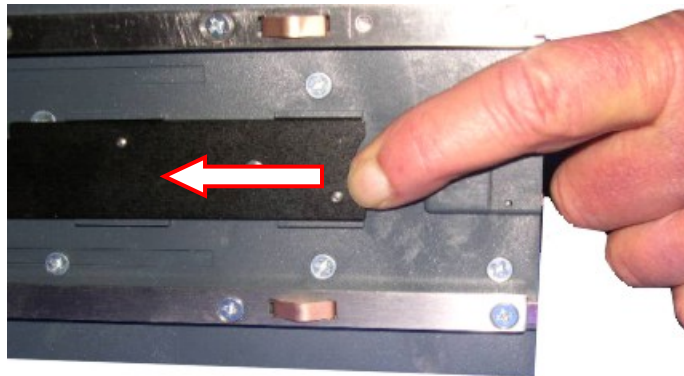

Figure 3-6 Push Release Bar

4 Ports and Dip Switches

Introduction

This chapter describes the interface connectors and port pin-outs for each model of the printer. For complete electrical specifications on these ports, refer to Appendix A in the Developers Manual (MNL-000004) for the power connector.

There are two models of the PSA-66-ST2 printer:

- **PSA-66-ST2N.** Netplex Interface. See page 12.
- **PSA-66-ST2R.** RS232 Interface. See page 16.



Note: While PSA-66-ST2 refers to both the PSA-66-ST2R and PSA-66-ST2N versions of the printer, this manual is written primarily for the RS232 interface. For additional information on the Netplex interface, please contact International Game Technology.

Front Bezel Port (All Models)

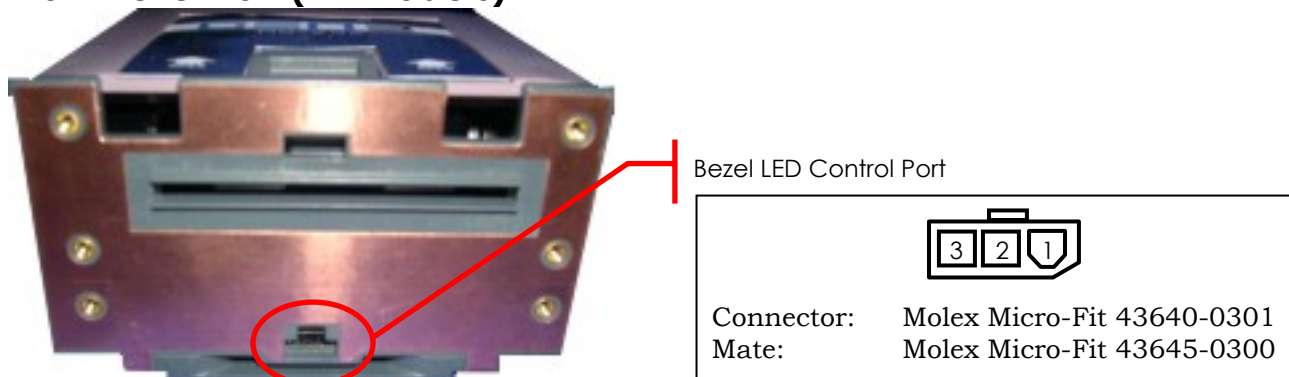

Figure 4-1 Front Bezel LED Control Port (All Models)

Table 4-1 lists information on the LED bezel port on the GEN2 printer. This is an open drain modulated high side drive 25VDC port capable of driving up to a maximum 1.5A.

Table 4-1 Front Bezel LED Control Port Pins (All Models)

Pin	Function
1	Switched 25VDC, 100mA Min
2	BGND
3	Frame (Chassis) Ground

PSA-66-ST2N (GEN2 Netplex Printer)

GEN2 Netplex Interface Cable

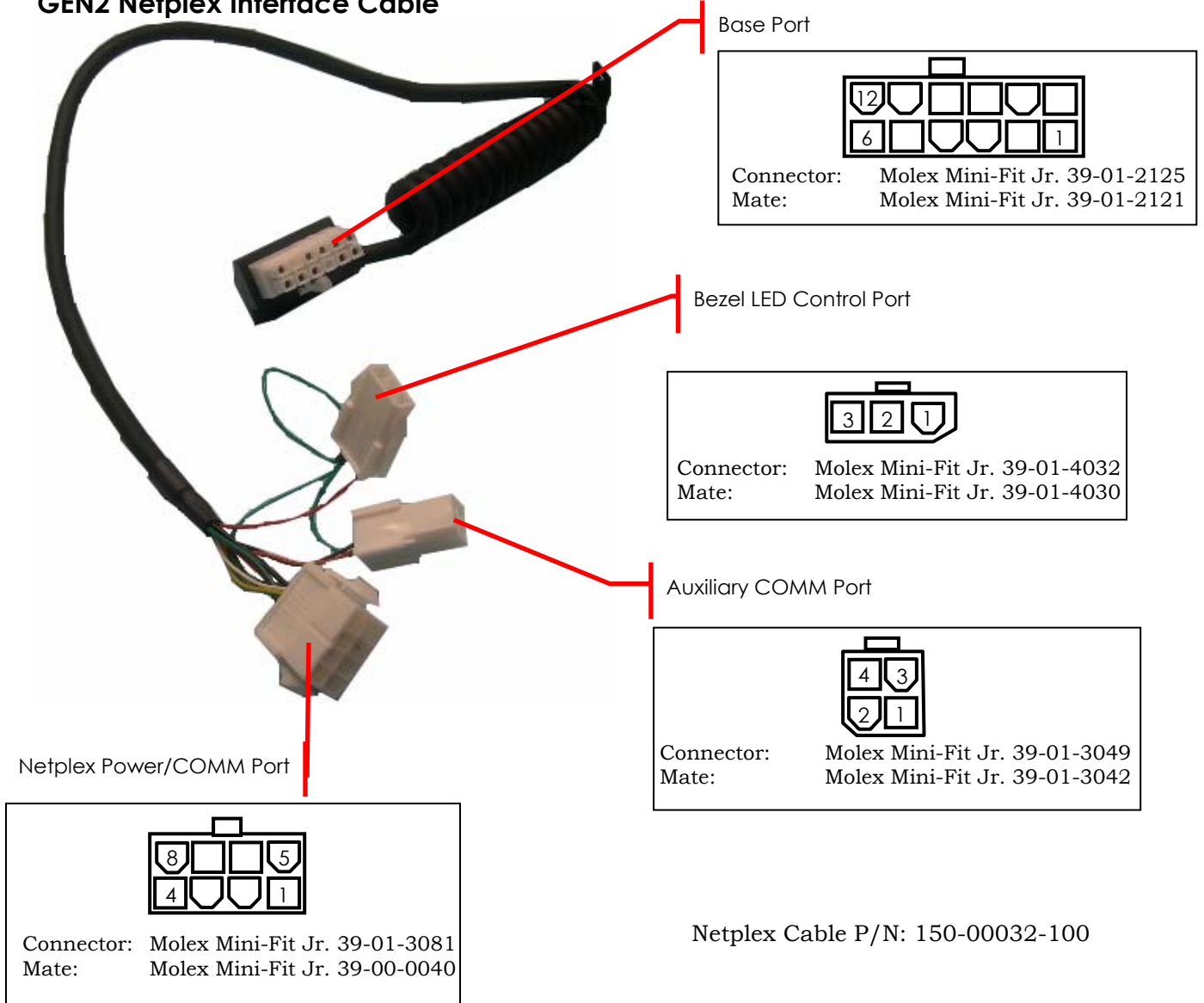

Figure 4-2

Netplex Interface Cable

Table 4-2 Bezel LED Port Pins

Pin	Function
1	Switched 25VDC, 100mA Min
2	NC
3	BGND

Table 4-3 Auxiliary COMM Port Pin-out

Pin	Function
1	GND
2	RX2
3	TX2
4	No Connect

Table 4-4 Netplex Power/COMM Port Pin-out

Pin	Function	I/O*
1	MRESET	I
2	Netplex TXD	I
3	+13V	-
4	Netplex RXD	O
5	NETGND	-
6	+25VDC	-
7	BGND	-
8	No Connect	-

Table 4-5 lists the pin-out of the 12 pin base port. The Modulated +24VDC pin has the same function as the bezel port pin.

Table 4-5 12 Pin Netplex Base Port Pins

Pin	Function
1	BGND (+24V Return)
2	NETPLEX RXD
3	+13VDC
4	SWITCHED +24VDC
5	No Connect
6	MRESET
7	NETPLEX TXD
8	+24VDC
9	No Connect
10	RX2
11	TX2
12	AGND

*I/O viewed from the printer



Note: The Bezel port on the rear of the printer is identical in function and characteristics to the one on the front of the printer.

GEN2 Netplex Firmware Upload Port

The Firmware Upload Port upgrades the printer firmware while the printer is still installed and powered in the game. The printer uploads through its Firmware Upload Port just as it would through its communications connector at the rear of the printer.

To use this port, slide the printer out until the upload port (shown in the following figure) is visible. Then plug an appropriate upgrade cable into the printer. This connection may be made while the power is on.

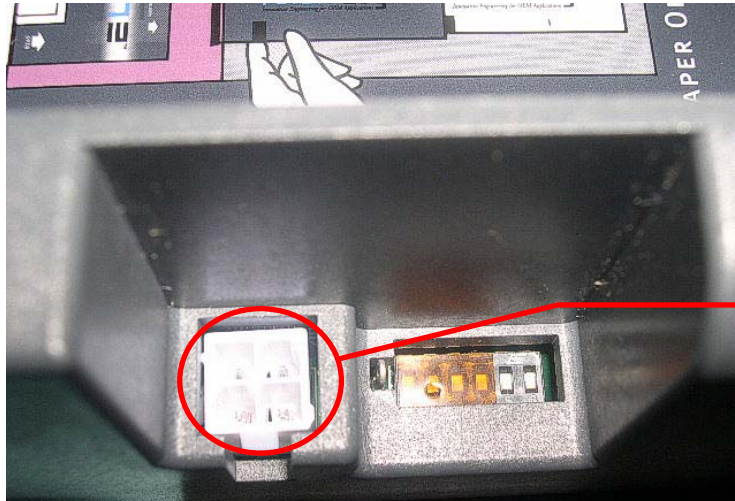

Firmware Upload Port

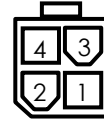

Connector: Molex Mini-Fit Jr. 39-31-0040
Mate: Molex Mini-Fit Jr. 39-01-3048

Figure 4-3 Netplex Firmware Upload Port

Table 4-6 Firmware Upload Port Pin-out

Pin	Function
1	Port Select
2	RX
3	TX
4	GND



Tip: Use the following diagram to make an upload cable.

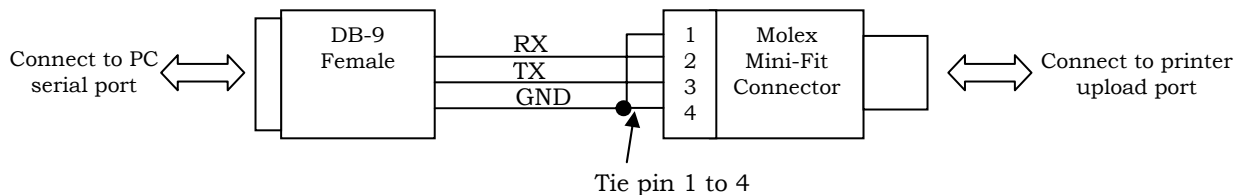

Figure 4-4 Upload Cable Diagram

GEN2 Netplex Dip Switches

The printer has a set of 6 dip switches accessible through a slot on the top of the printer. Use the dip switches to select the communications protocol. The switches **must** be set according to Table 4-7 for proper operation.

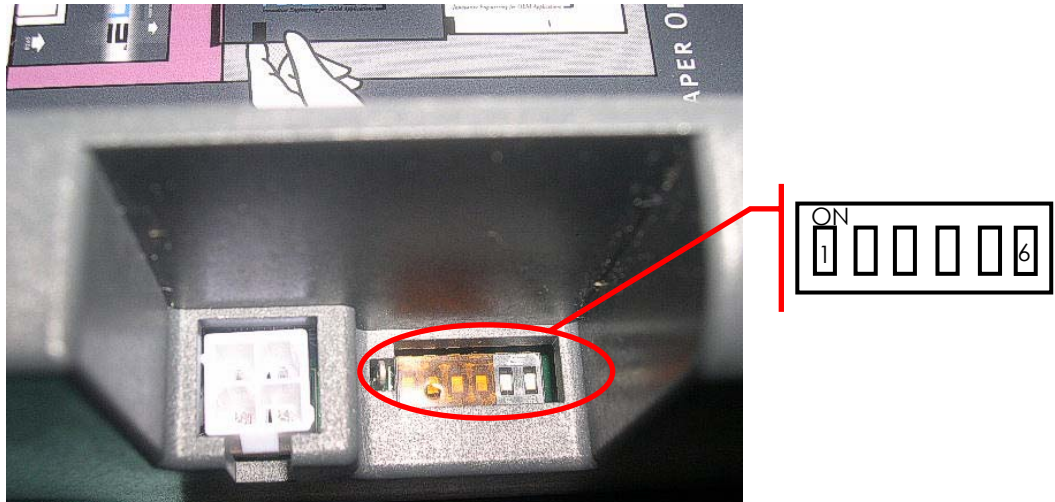

Figure 4-5 Netplex Dip Switches – Top View

Table 4-7 Netplex 6 Position Dip Switch Settings

Pos	Function	Configuration
1	Reserved	OFF
2	Baud Rate	ON
3	Baud Rate	OFF
4	Hand Shaking	OFF
5	Reserved	OFF
6	Reserved	OFF

Note: Do not turn “reserved” switches ON.

PSA-66-ST2R (GEN2 RS232 Printer)

GEN2 RS232 Interface Cable – 12 Pin Coiled Cable

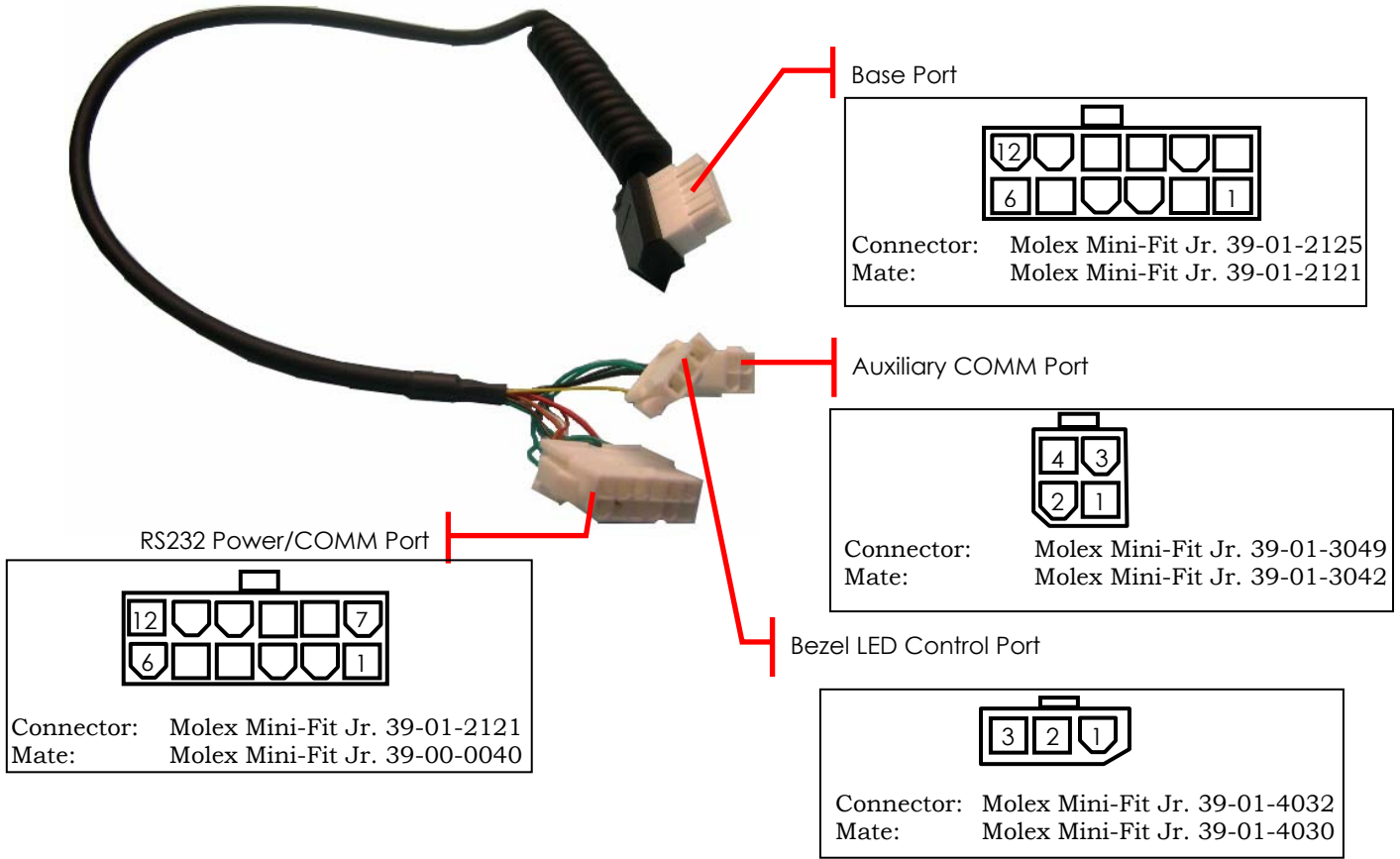

Table 4-8 Auxiliary COMM Port Pin-out

Pin	Function
1	GND
2	RX2
3	TX2
4	no connect

Table 4-9 Bezel LED Port Pins

Pin	Function
1	Switched 25VDC, 100mA Min
2	NC
3	BGND

RS232 12 Pin Coiled Cable P/N: 150-00035-100
RS232 Eval Cable P/N: 150-00044-100

Figure 4-6 RS232 Interface Cable, 12 Pin Coiled

Table 4-10 RS232 Power/COMM Port Pin-out

Pin	Function	I/O
1	MRESET	I
2	TXD	O
3	+12VDC (optional)	-
4	RXD	I
5	GND	-
6	+24VDC	-
7	BGND	-
8	+24VDC	-
9	No Connect	-
10	No Connect	-
11	DTR	O
12	RTS	O

The \MRESET signal on the RS232 Power/COMM Port allows the printer to be reset when this signal is driven to GND. For normal operation leave the \MRESET pin unconnected. For \MRESET function, GND must be supplied to the printer through pin #1.

Table 4-11 lists the pin-out of the 12 pin base port. The Modulated +24VDC pin has the same function as the bezel port pin. The function of MRESET is described for the RS232 port above.

Table 4-11 12 Pin RS232 Base Port Pins

Pin	Function
1	BGND (+24V Return)
2	PRINTER TX1
3	No Connect
4	SWITCHED +24VDC
5	DTR
6	MRESET
7	PRINTER RX1
8	+24VDC
9	RTS
10	RX2
11	TX2
12	No Connect

*I/O viewed from the printer



Note: The Bezel port on the rear of the printer is identical in function and characteristics to the one on the front of the printer.

GEN2 RS232 Interface Cable – 14 Pin Coiled Cable

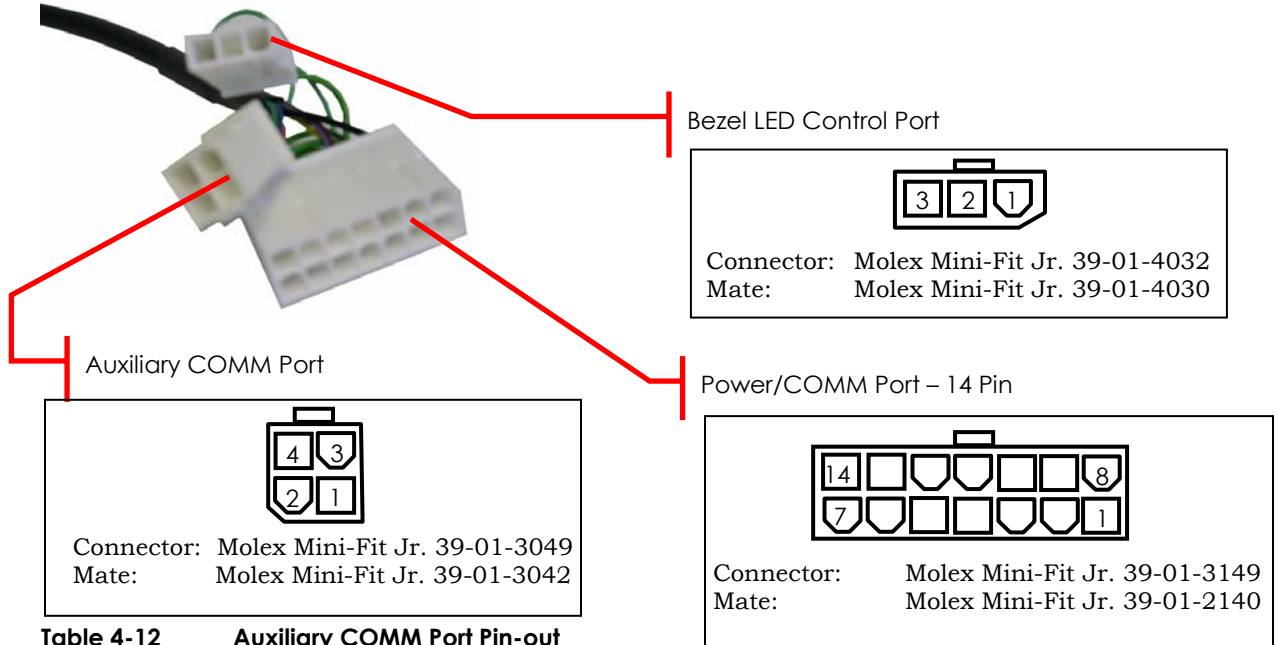

Table 4-12 Auxiliary COMM Port Pin-out

Pin	Function
1	GND
2	RX2
3	TX2
4	no connect

Table 4-13 RS232 Power/COMM Port 14 Pin-out

Pin	Function
1	MRESET
2	Netplex TXD
3	+12 VDC (RS232 optional)
4	Netplex RXD
5	GND
6	+24 VDC
7	GND
8	+24 VDC
9	Modulated +24VDC
10	GND
11	RS232 RXD
12	RS232 TXD
13	DTR
14	RTS

RS232 14 Pin Coiled Cable P/N: 150-00047-100

Figure 4-7 RS232 Interface Cable, 14 Pin Coiled

GEN2 RS232 Adapter Cable – 12 Pin to 14 Pin

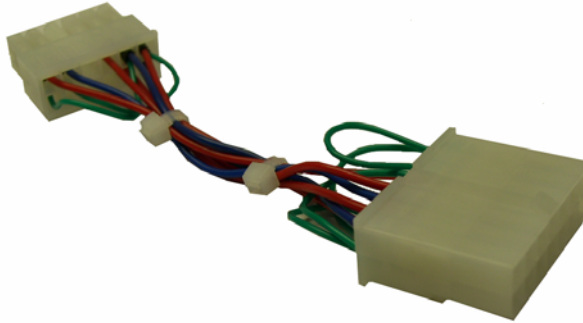

Figure 4-8 RS232 Adapter Cable

Table 4-14 RS232 Adapter Cable Pin-outs

Pin	Function
1	MRSET
2	No connect
3	No connect
4	No connect
5	GND
6	+24VDC
7	GND
8	+24VDC
9	+24VDC
10	GND
11	RX1
12	TX1
13	DTR
14	RTS

RS232 Adapter Cable P/N 150-00043

GEN2 RS232 Evaluation Cable

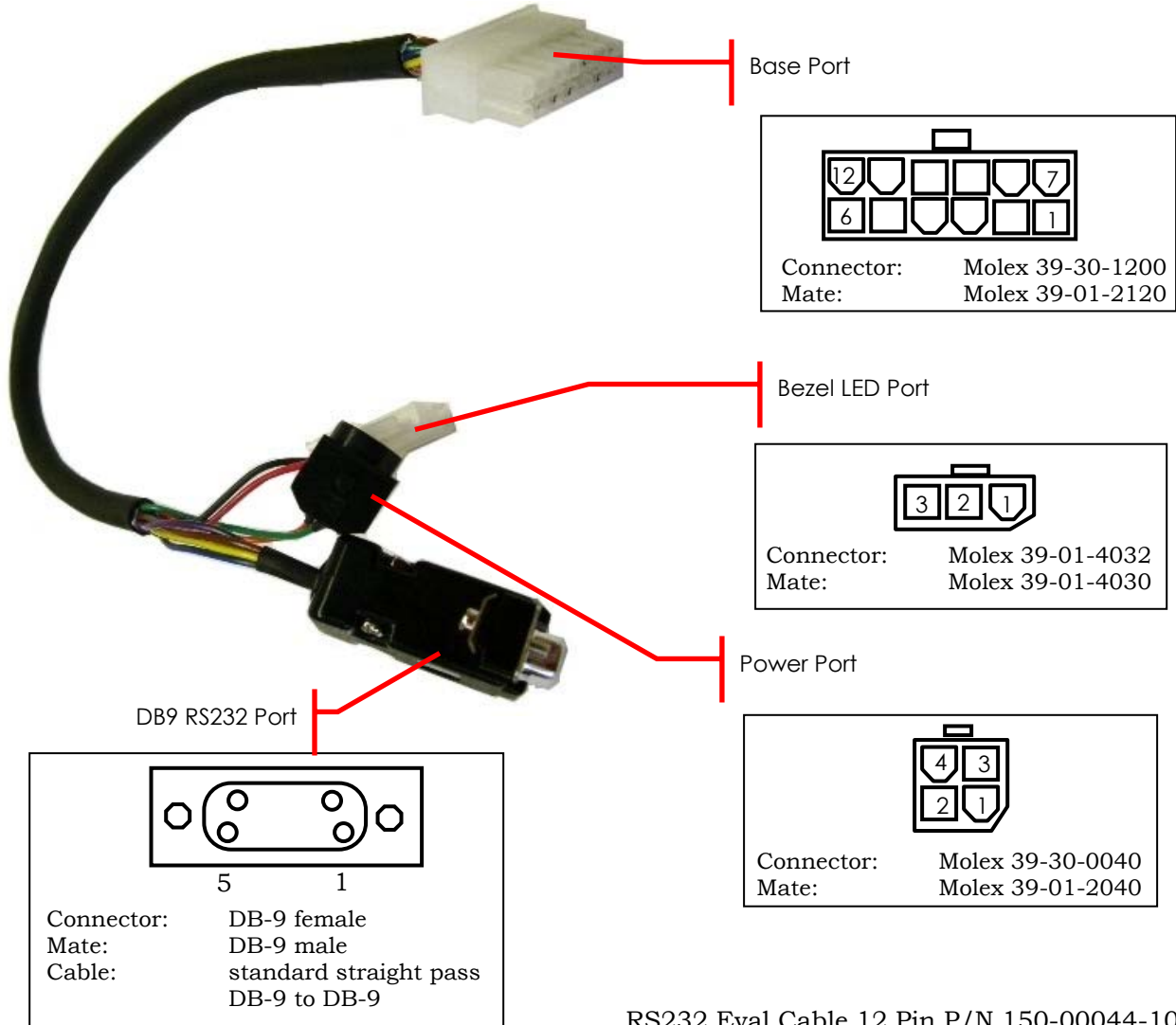

RS232 Eval Cable 12 Pin P/N 150-00044-100

Figure 4-9 RS232 Evaluation Cable

The Bezel port on the rear of the unit is identical in function and characteristics to the one on the front of the unit described earlier.

Table 4-15 Bezel Port Pins

Pin	Function
1	Modulated +24VDC
2	No connect
3	GND

The following table lists the pin out of the 12 pin base port. The Modulated +24VDC pin has the same function as the bezel port pin.

Table 4-16 12 pin Base Port Pins

Pin	Function	I/O*
1	+24VDC	-
2	TXD	O
3	RXD	I
4	DSR	-
5	GND	-
6	DTR	O
7	CTS	-
8	RTS	O
9	Modulated +24VDC	O
10	GND	-
11	GND	-
12	+24VDC	

*I/O viewed from the printer

Table 4-17 14 pin Base Port Pins

Pin	Function	I/O*
1	MRESET	I
2	Netplex TXD	I
3	+12 VDC (RS232 optional)	I
4	Netplex RXD	O
5	GND	-
6	+24 VDC	-
7	GND	-
8	+24 VDC	-
9	Modulated +24VDC	O
10	GND	-
11	RS232 RXD	I
12	RS232 TXD	O
13	DTR	O
14	RTS	O

*I/O viewed from the printer

Table 4-18 DB9 RS232 Port Pins

Pin	Function	I/O*
1	No connect	-
2	TX	O
3	RX	I
4	DSR	I
5	GND	-
6	DTR	O
7	CTS	I
8	RTS	O
9	No connect	-

I/O viewed from the printer

GEN2 RS232 Firmware Upload Port

The Firmware Upload Port upgrades the printer firmware while the printer is still installed and powered in the game. The printer uploads through its Firmware Upload Port just as it would through its communications connector at the rear of the printer.

To use this port, slide the printer out until the upload port (shown in the following figure) is visible. Then plug an appropriate upgrade cable into the printer. This connection may be made while the power is on.

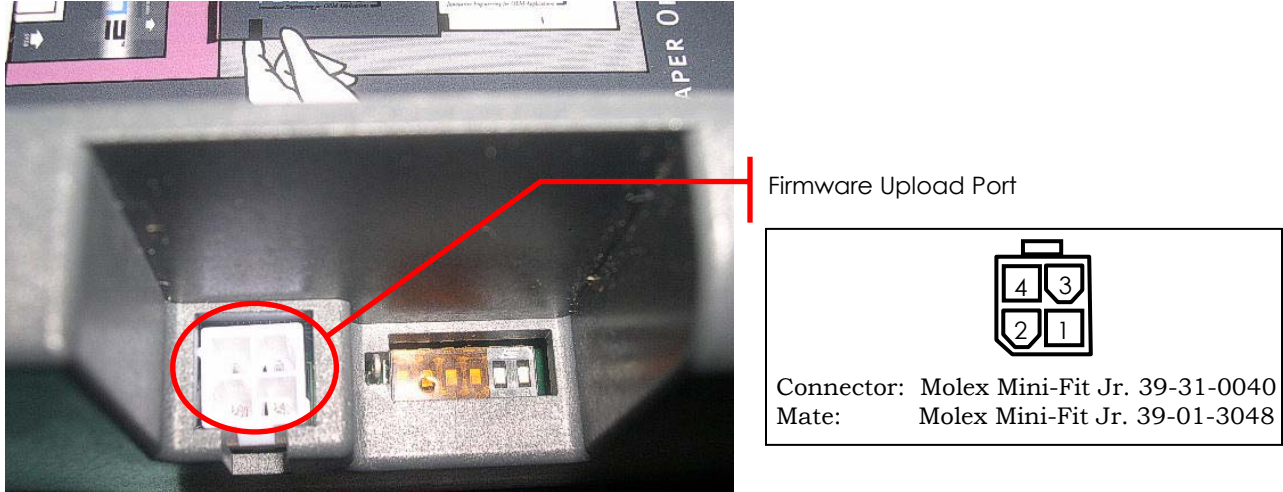

Figure 4-10 RS232 Firmware Upload Port

Table 4-19 Firmware Upload Port Pin-out

Pin	Function
1	Port Select
2	RX
3	TX
4	GND



Tip: Use the following diagram to make an upload cable.

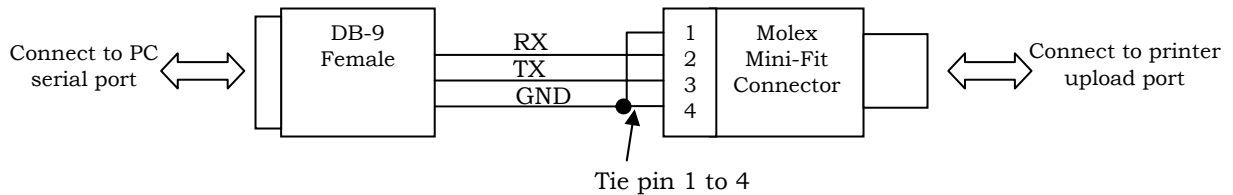

Figure 4-11 Upload Cable Diagram

GEN2 RS232 Dip Switches

The printer has a set of six dip switches accessible through a slot on the top of the stationary module. The dip switches are used to select the communications protocol. The switches ***must*** be set according to Table 4-20.

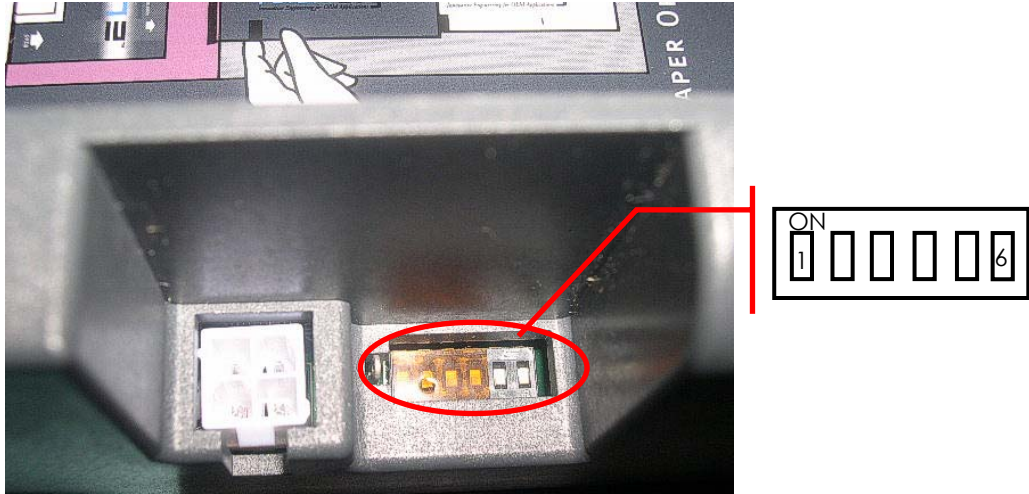

Figure 4-12 Dip Switches – Top View

Table 4-20 RS232 6 Position Dip Switch Settings

MODE	SW1 (JMPR3)	SW2 (JMPR2)	SW3 (JMPR1)	SW4 (JMPR0)
9600	ON	ON	X	X
38400	OFF	ON	X	X
57600	OFF	ON	ON	X
XON/XOFF + RTS	X	X	X	OFF
RTS	X	X	X	ON

Appendix A Technical Specifications

This appendix identifies the general specifications of the GEN2 printer.

General	
Dimensions (WxDxH)	110mm x 304.8mm x 64.3mm
Weight	2.7 lbs.
Power Requirements	24VDC @ 2.7A avg.
Sensors	Paper Low, Paper Out, Printer Drawer Open, Ticket Taken, Ticket Jam, Ticket in Chute, Black Mark (Includes a Host Controllable Buzzer)
Printing Speed	90mm/Second (3.5"/Second)
Print and Present	2.2 Seconds
Printing Width	62mm (true near-edge printing)
Storage	300 Tickets
Ticket Tray Extenders	Interchangeable, 600, 900 Ticket Tray
Resolution	8 dots/mm (203 dpi)
Firmware	Application in Memory is Reprogrammable (via Flash BIOS)
Self Test	Yes
Page Mode	Full Page Mode Printing (Simultaneous 4 Orientation Printing: 0°, 90°, 180°, 270°) Line and Box Draw Printer Resident Bitmap Graphics Printer Resident (Stored in Flash) Graphics
Paper Loading	Automatic Hands Free
Paper Feed	Manual
Method	Direct Thermal, Top Coated, Fanfolded and Perforated
Width	66mm
Length	156mm
Thickness	4.5 mil, 1 Color/2 Colors
Bezel Control	Two High Current Ticket Printing Bezel Control Ports
User Interface	4 LED Indicators, Paper Advance Button
Update Port	Allows for Printer Upgrades via Handheld Download Tool
Hot Swappable	100%
Printing Resources	
Template Capacity	8MB; Stores hundreds of clip art objects & thousands of graphic templates
Graphic Storage	6MB
Color Printing	Red on Black and Blue on Black are available. Other colors can be supported as the print media becomes available. Color selection is controlled through the TCL language.

Characteristics	
Printer Languages	TCL Printer Language (Page Description Language) Subset of ESCP2
Fonts	4 (5.5 cpi, 7.5 cpi, 10 cpi, 20 cpi)
Font Scalability	May Be Independently Scaled from 1x – 7x in Both Height and Width
Bar codes	Interleaved 2 of 5, Code 39, UPC-A, UPC-E, UPC-E+2, UPC-E+5, Codabar, EAN-13, EAN-8, Code 128, MSI
Memory	1MB with 128k RAM
Interface	
Communications	Bi-directional RS232C, Full Handshaking Set Netplex
Environmental	
Operating temperature	5°C to 65°C
Storage temperature	-20°C to 75°C
Operating humidity	5 to 95% RH
Reliability	
Maintenance	No User Maintenance Required Printer Completely Removable with Quick Release Bar
Print Head Life	50km Min. (320,000 Tickets Based on US Currency Size)
Certifications	CE Certified, ISO 9001, RoHS

Appendix B Paper Specifications

This appendix provides information on the paper used in the GEN2 printer. Please contact FutureLogic, Inc. or your sales representative for more information on approved papers and complete paper specifications.

For authorized ticket converters, visit our Web site: www.futurelogic-inc.com.



Note: Use only approved paper in the printer. Use of improper paper may cause damage to the device and will void the printer's warranty.

Nominal paper thickness: 4.5mil
Paper dimensions: 65mm x 156mm (width dimension ± 1 mm)

Ticket Stack
Ticket, 300STK, 65X156, 5M, Fanfold
Ticket, 600STK, 65X156, 5M, Fanfold
Ticket, 900STK, 65X156, 5M, Fanfold

Note: Paper width is +0mm, -1mm.

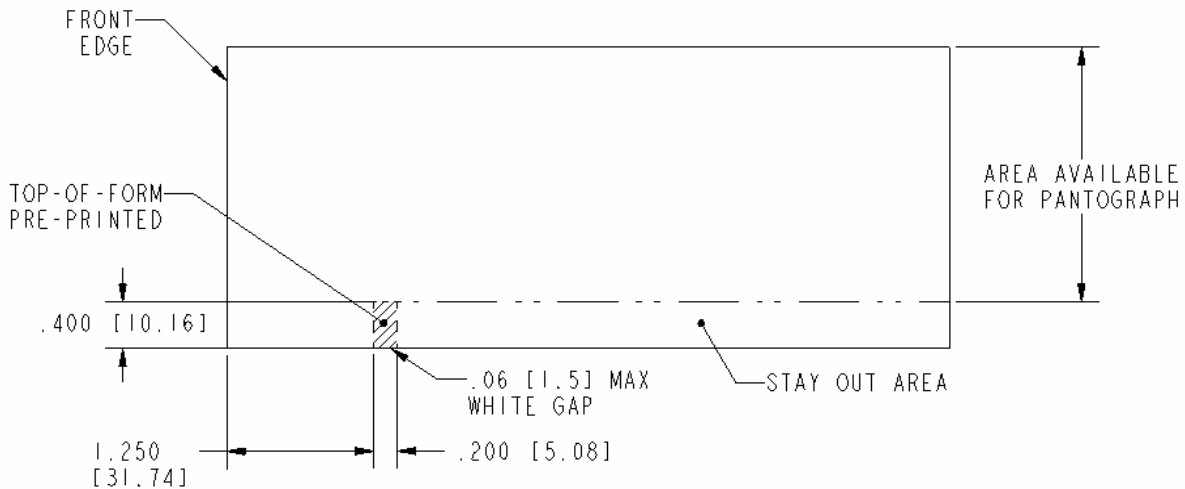

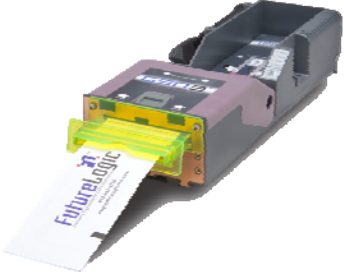



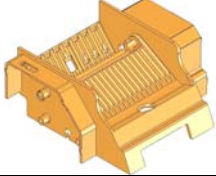

Figure B-1 Ticket Dimensional Specification







Appendix C Part Numbers – Printer/Spares

This appendix provides the part number and description of the GEN2 printers and spares.

Printers – P/N	Description	
220-00035-100	GEN2 Printer, PSA-66-ST2N, Netplex*, RoHS	<p>RoHS Versions—Look for either of these labels:</p> 
220-00037-100	GEN2 Printer, PSA-66-ST2R, RS232, RoHS	
		

*Netplex equipped printers meet the Netplex specification of International Game Technology Corporation. For additional information, please contact IGT.

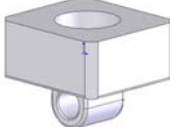
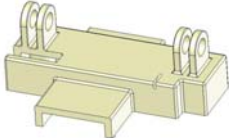
Spares – P/N	Description	
370-00015-100	Base RoHS	
370-00018-100	Bottom Chute RoHS	
150-00043	Cable, Adapter, RS232, 12 pin to 14 pin	
150-00032-100	Cable, Coiled, Netplex RoHS	

Spares – P/N	Description	
150-00035-100	Cable, Coiled, RS232, 12 pin RoHS	
150-00047-100	Cable, Coiled, RS232, 14 pin RoHS	
150-00045-100	Cable, Display Adapter RoHS	
150-00044-100	Cable, Evaluation, RS232, 12 pin RoHS	
150-00013-100	Cable, Evaluation, RS232, 14 pin RoHS	
370-00021-100	Floating Part RoHS	
370-00024-100	Hinge RoHS	
370-00025-100	Hinge Pin RoHS	

Spares – P/N	Description	
500-00005-100	Keypad Membrane RoHS	
362-00047-101	Label, Lid, Top, PSA-66-ST2N RoHS	
362-00047-102	Label, Lid, Top, PSA-66-ST2R RoHS	
370-00020-100	Lid, Top, Purple RoHS	
370-00022-100	Locker RoHS	
370-00023-100	Locker Base RoHS	
370-00016-100	Main Bracket RoHS	
140-00030	Mother Board RS232, 1 COMM Port	
140-00030	Mother Board, Netplex, 1 COMM Port	
140-00030	Mother Board, Netplex, 2 COMM Ports	
140-00030	Mother Board, RS232, 2 COMM Ports	

Spares – P/N	Description	
140-00099-100	Paper Low Sensor Board RoHS	
460-00005-100	Platen Shaft Assembly RoHS	
350-00031-102	Power Supply RoHS	
400-00007-100	Print Mech, F03-66 RoHS	
310-00112-100	Release Bar Bracket RoHS	
310-00115-100	Release Bar Guide RoHS	
460-00006-100	Roller Idler RoHS	
473-00078-100	Screws (100 pack) RoHS	
485-00008-100	Spring (50 pack) RoHS	
370-00026-100	Spring Plate RoHS	

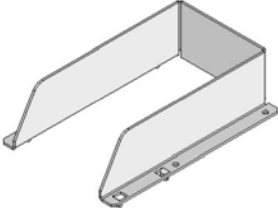
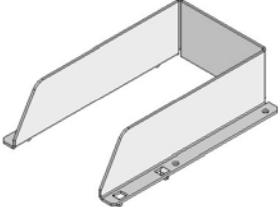
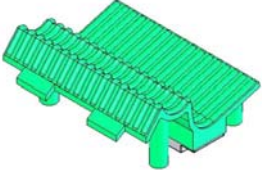
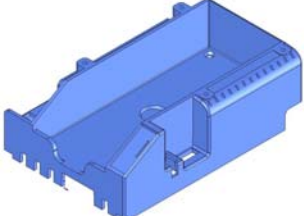
Spares – P/N	Description	
482-00012-100	Star Washers (100 pack) RoHS	
320-00224-101	Ticket Extension Tray, 600 Tickets RoHS	
320-00224-102	Ticket Extension Tray, 900 Tickets RoHS	
370-00019-100	Top Presenter RoHS	
370-00017-100	Tray, Paper RoHS	

Appendix D Part Numbers – Bezels

The following bezel systems are designed to bolt to the four M3 holes on the front chassis plate of the GEN2 printer.

P/N	Description	
130-00024-100	Bezel RoHS	
130-00007	Bezel Assembly, Ticket Out, EZ Pay	
130-00008	Bezel Assembly, Ticket Out, LXS, S/T, EZ Pay	
130-00017-100	Bezel Assembly, Top Box, EZ Pay RoHS	
130-00009-100	Bezel, BZL,SHORT,ANGLED_FLG,ROHS,YEL	
130-00021-100	Bezel, BZL,LONG,ANGLED_FLG,ROHS,YEL	
310-00239	Bracket, Bezel, 19" Upright, GK+SST	
310-00240	Bracket, Bezel, 19" Upright, GKTIGOLD	

P/N	Description	
310-00244	Bracket, Bezel, GK, 17" Upright, SST	
310-00243	Bracket, Bezel, GK, 17" Upright, TI	
310-00241	Bracket, Bezel, S2K, TB, SST	
310-00242	Bracket, Bezel, S2K, TB, TI GOLD	
310-00238	Bracket, Mount, EZ Pay, TB, 17" Upright	
140-00096-100	PCBA,LED_LONG,GEN2,GRN RoHS	
140-00096-101	PCBA,LED_LONG,GEN2,BLU, RoHS	
140-00044	PCBA, Vis, Wide Bz Lt, EZ Pay	

Appendix E Schematics

The schematics included in this appendix are provided solely for use by technicians who service the GEN2 printer. This information is provided AS IS and without warranty, expressed or implied.



Note: The information contained in the following schematics is copyrighted information and is the exclusive intellectual property of FutureLogic, Incorporated. All rights are reserved. No transfer or grant of rights is created by the publication of this information.

Working on the PCBA

When working on the PCBA, Install ground lug with two wires from ground cable assembly onto PCBA using a #6x1/4 screw (473-00079-100) where shown. Torque to 5.0 in-lbs. Bend lug upwards 90 degrees as shown. Wrap 'J5' wire around post as shown.

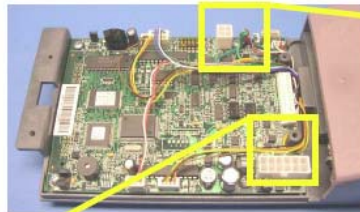

Install ground lug and screw here, bend lug upwards 90 degrees

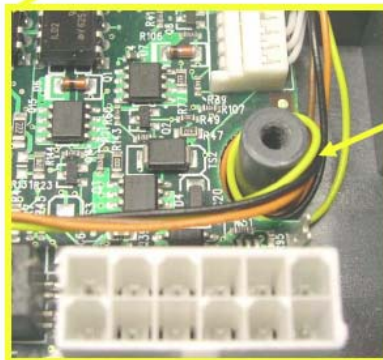

Wrap 'J5' wires around post

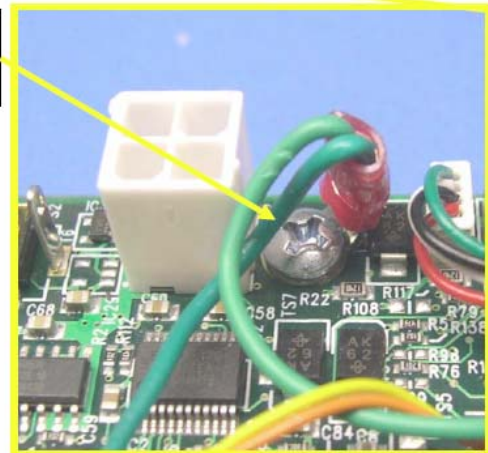

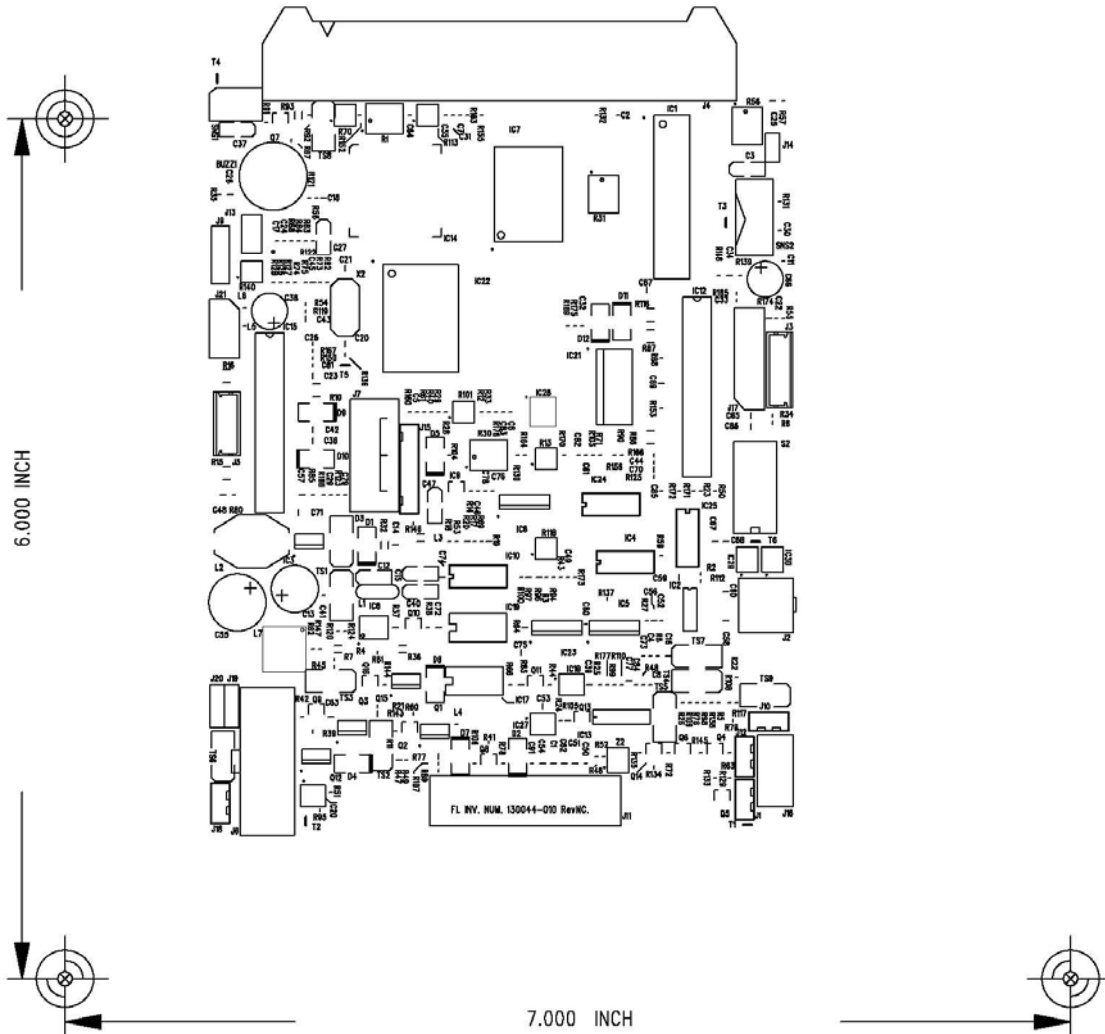

FUTURELOGIC INC.		
ENGINEER: M.BURBAN PHONE: 818-244-4700	TITLE: PMC 2010 "ST2"	FILE NAME: GEN2KC7NC.PCB
ENGINEER: D.SPARGUR PHONE: 818-244-4700	PART NO.: 130044-010 - ART	REV: NC DATE: 04.13.04
		GERBER: GEN2KC TS.PHO

This information is copyrighted material and is the exclusive intellectual property of FutureLogic, Incorporated. All rights are reserved.

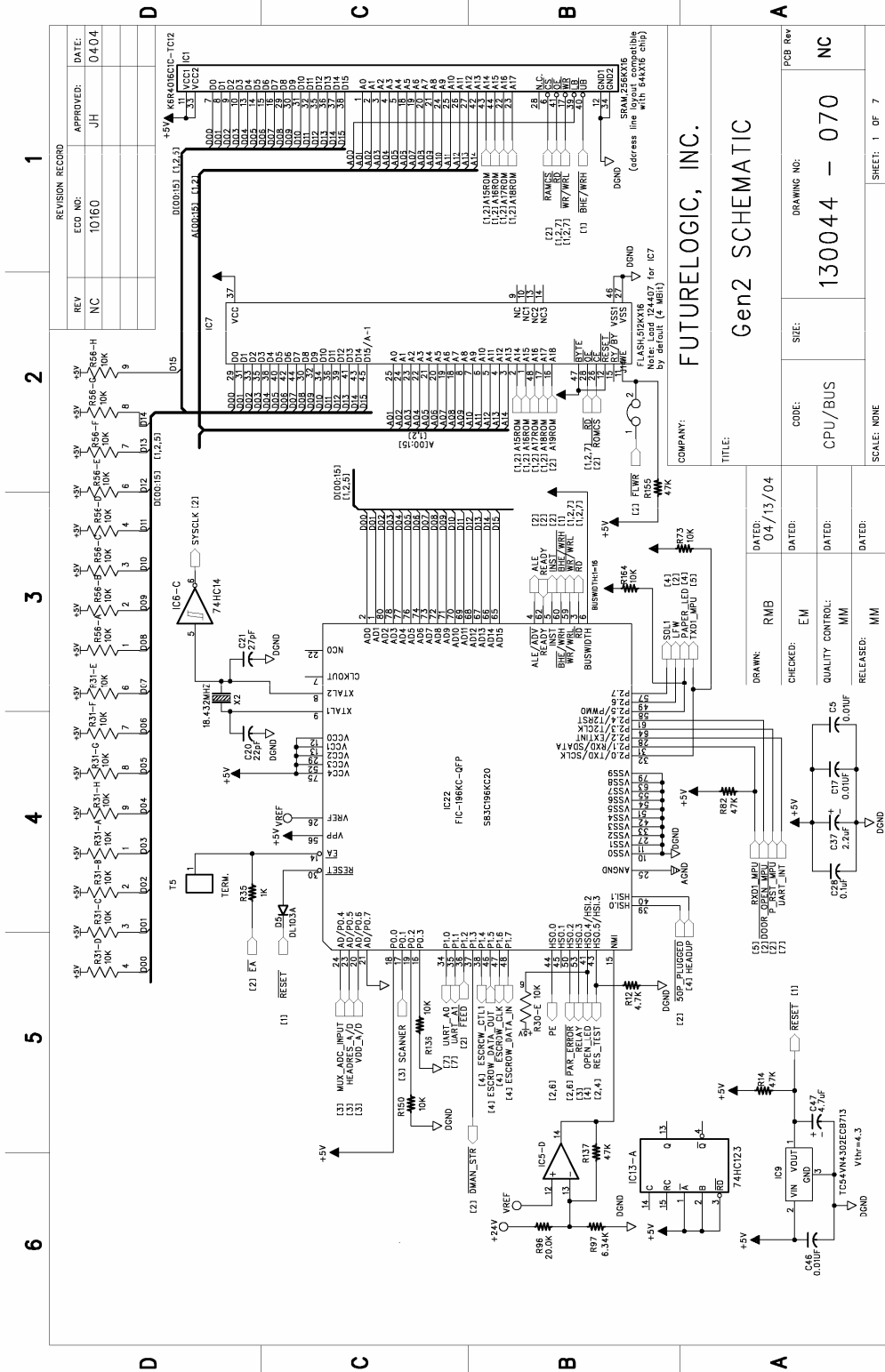

This information is copyrighted material and is the exclusive intellectual property of FutureLogic, Incorporated. All rights are reserved.

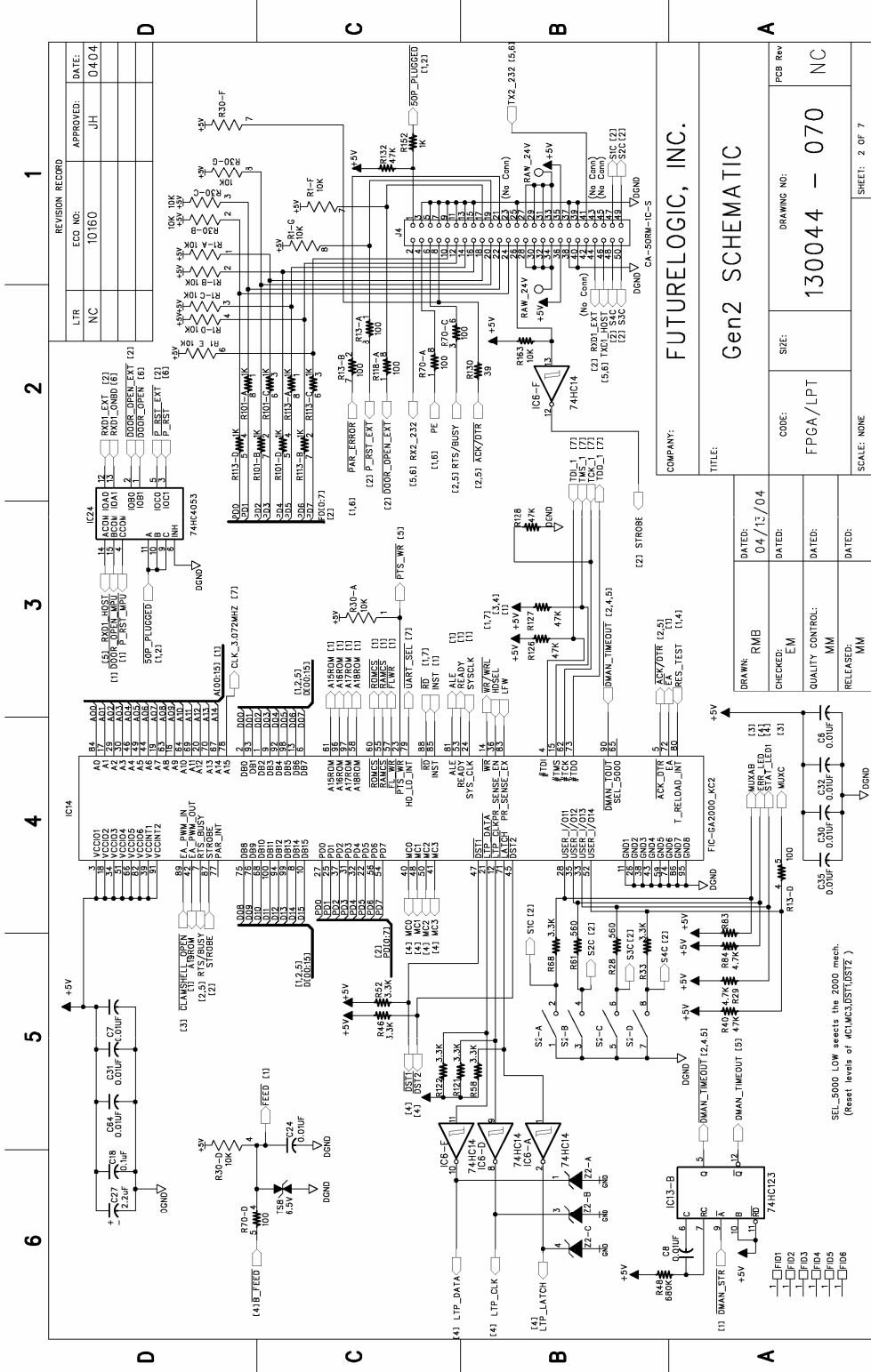

This information is copyrighted material and is the exclusive intellectual property of FutureLogic, Incorporated. All rights are reserved.

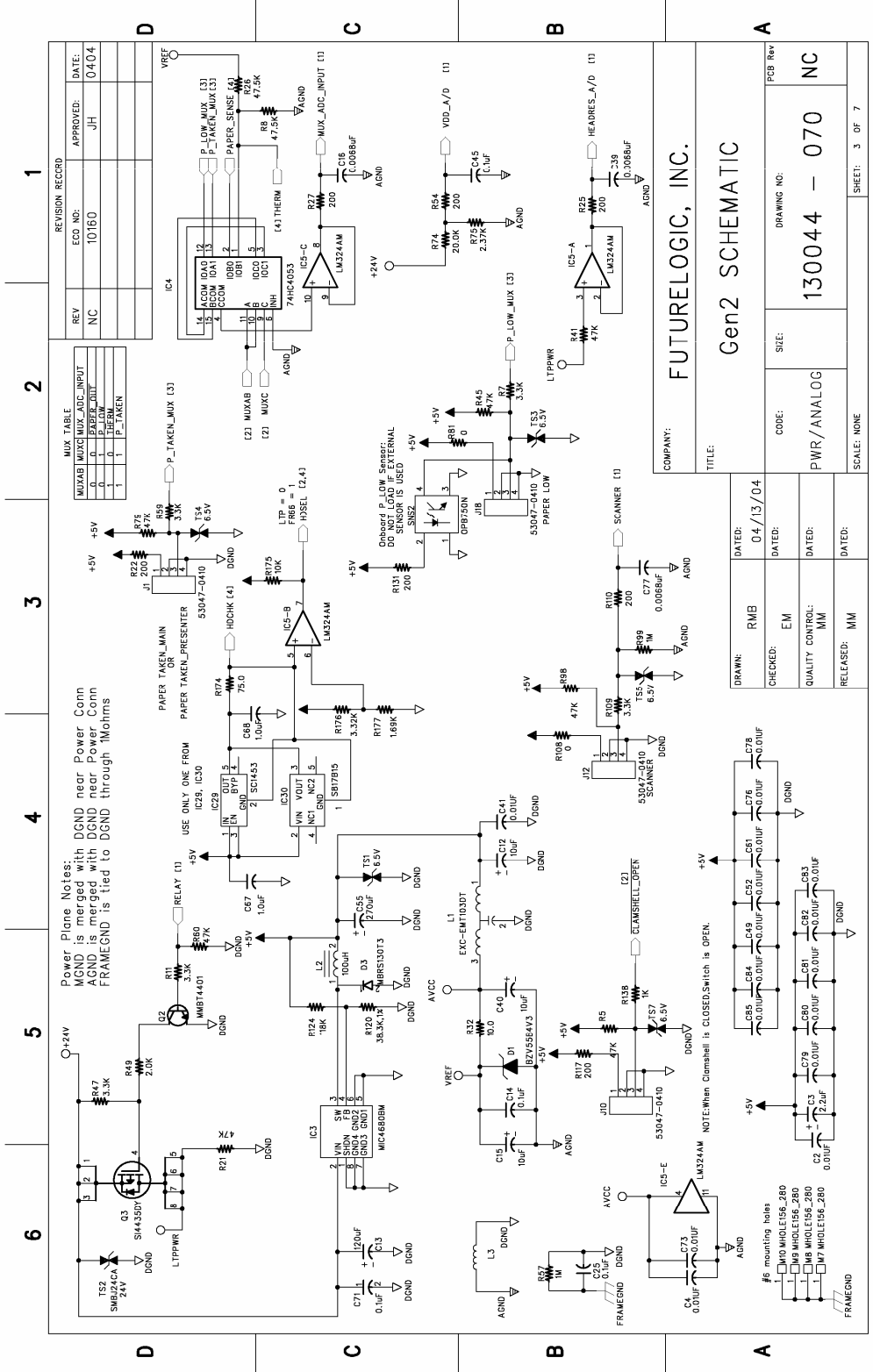

This information is copyrighted material and is the exclusive intellectual property of FutureLogic, Incorporated. All rights are reserved.

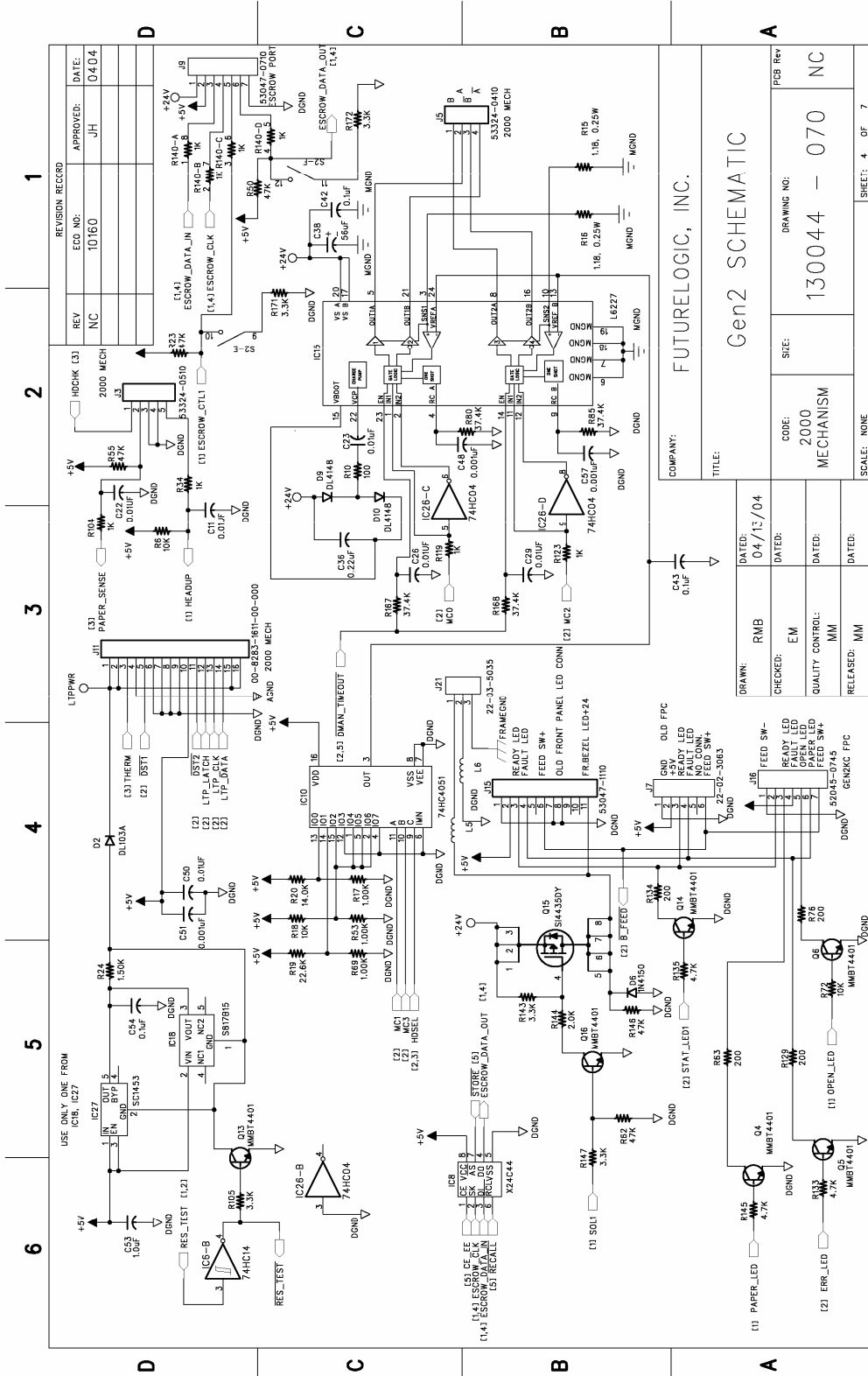

This information is copyrighted material and is the exclusive intellectual property of FutureLogic, Incorporated. All rights are reserved.

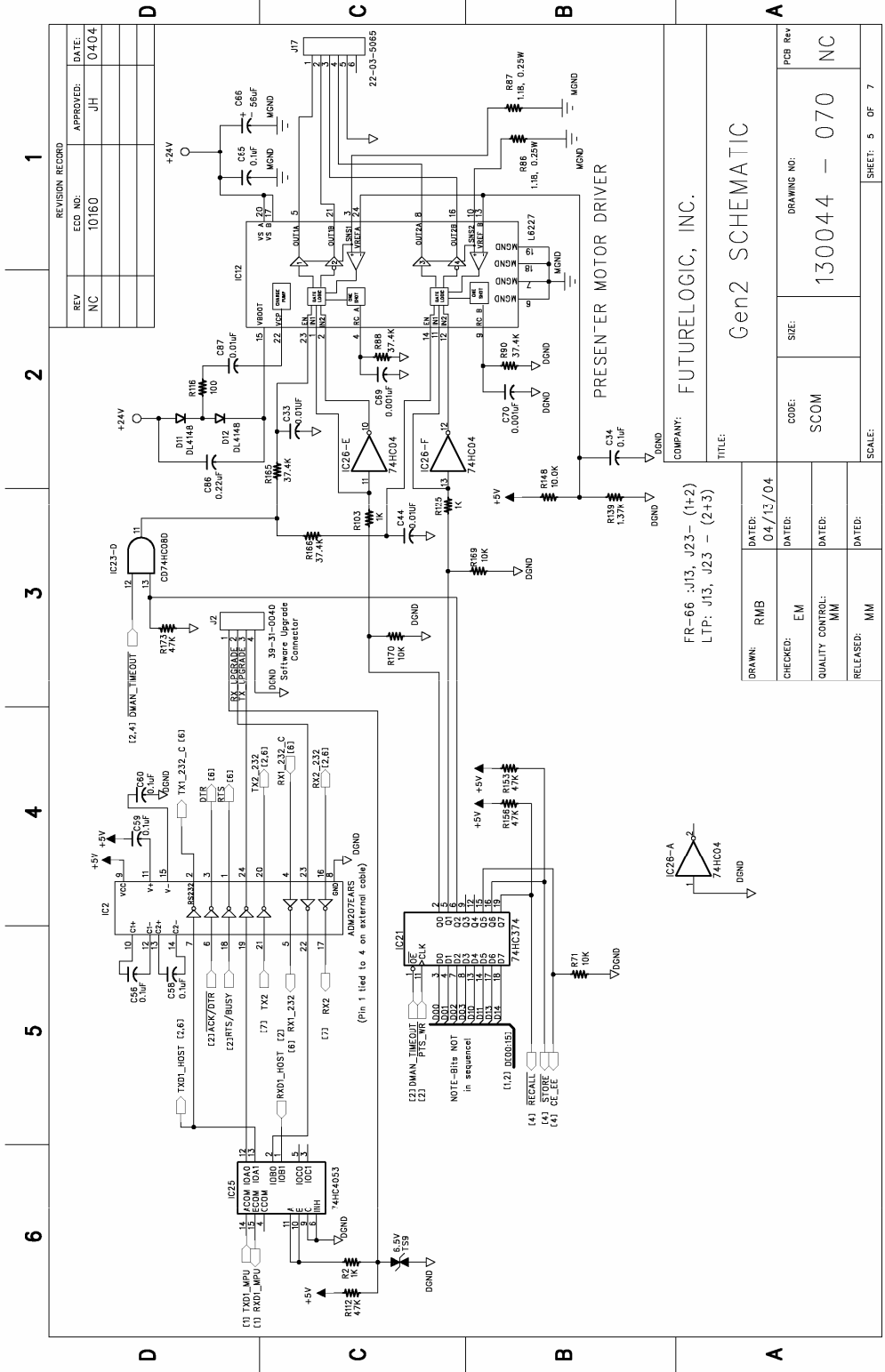

This information is copyrighted material and is the exclusive intellectual property of FutureLogic, Incorporated. All rights are reserved.

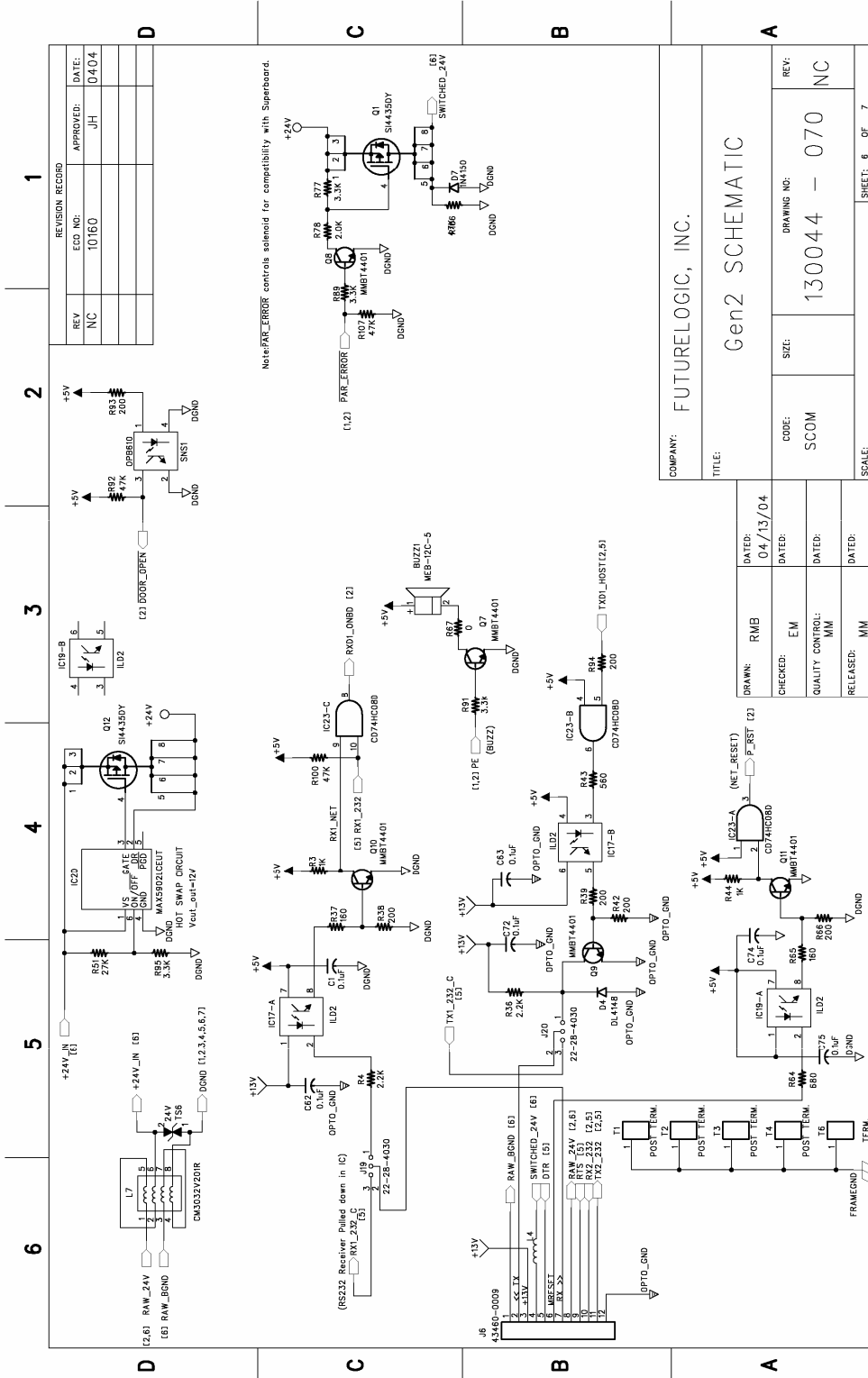

This information is copyrighted material and is the exclusive intellectual property of FutureLogic, Incorporated. All rights are reserved.

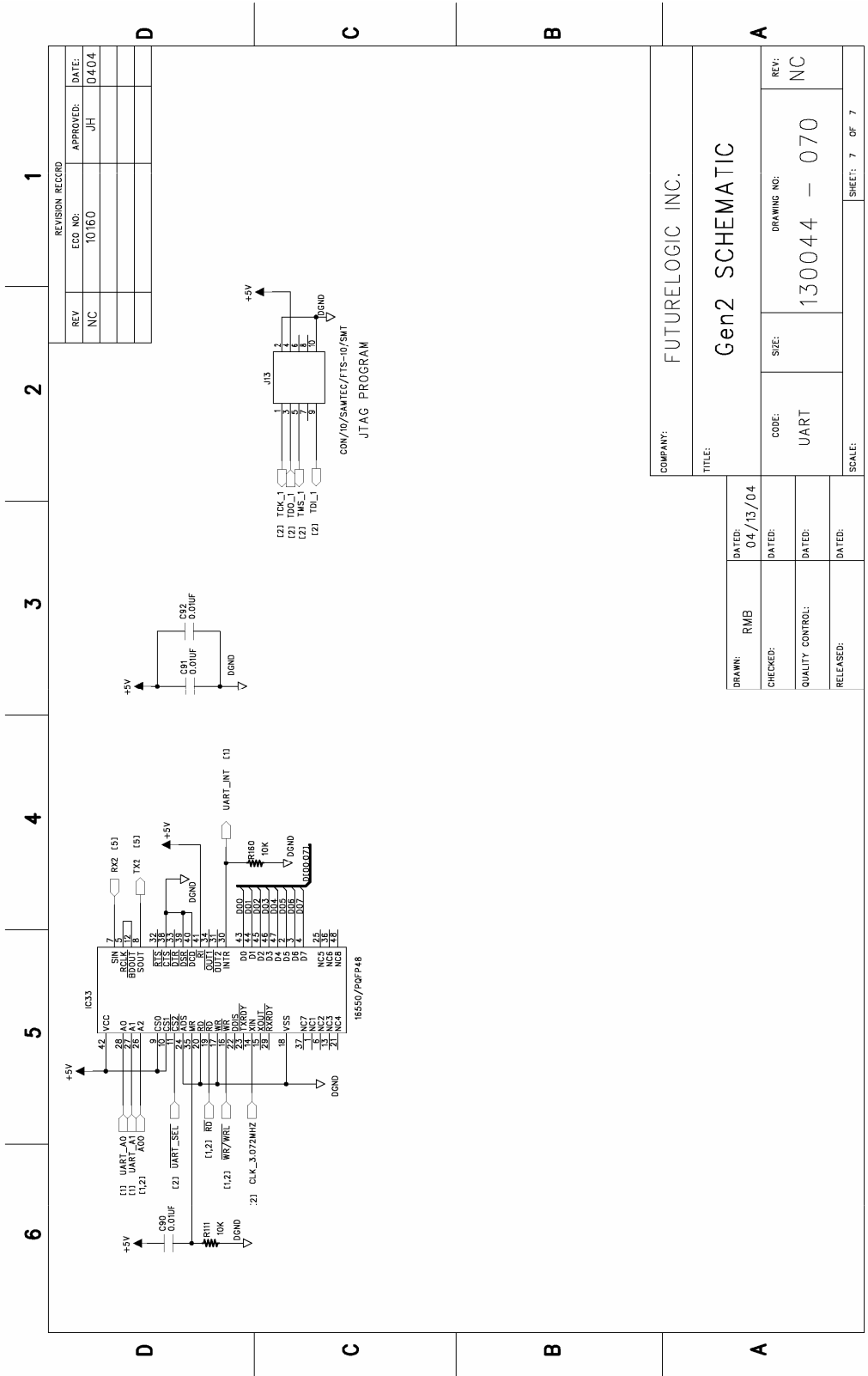

This information is copyrighted material and is the exclusive intellectual property of FutureLogic, Incorporated. All rights are reserved.

3	2	1
	C	B

ZONE	REV.	DESCRIPTION	DATE	APPD.

REV. 1	DESCRIPTION	DATE

1S:PHO

DESIGNER	CHECKED	DATE	APPD.

UNITED STATES PATENT & TRADEMARK OFFICE PATENT NO. 7,208,982 4/12/04	CONTRACT NO. 423 E. COLWOOD ST., STE. 100 GARDEN CITY, CA 94026	DRIVING TITLE GEN2-P9 - ASSEMBLY
ANGLES: 1/4" - 1/8" 1/4" - 1/8" 3/16" - 1/8" 3/16" - 1/8" 1/8" - 1/8" 1/8" - 1/8"	SCALE: C	FOR REV. X04

NOTE:
1. DO NOT INSTALL TOGETHER SNE2 AND J13, I023 AND J15.

CONTRACT NO. 423 E. COLWOOD ST., STE. 100 GARDEN CITY, CA 94026	DRIVING TITLE GEN2-P9 - ASSEMBLY	FOR REV. X04
ANGLES: 1/4" - 1/8" 1/4" - 1/8" 3/16" - 1/8" 3/16" - 1/8" 1/8" - 1/8" 1/8" - 1/8"	SCALE: C	FOR REV. X04

PROPRIETARY NOTE INFORMATION DISCLOSED HEREIN IS THE PROPERTY OF FUTURELOGIC, INC. AND SHALL NOT BE USED FOR ANY OTHER PURPOSE EXCEPT AS STIPULATED BY CONTRACT BETWEEN THE EQUIPSET AND FUTURELOGIC, INC.	REV. 1	DESCRIPTION	DATE	APPD.
--	---------------	--------------------	-------------	--------------

This information is copyrighted material and is the exclusive intellectual property of FutureLogic, Incorporated. All rights are reserved.

Appendix F Service Tool Kit

This appendix identifies the components of a service tool kit a technician may use to perform a repair on a PSA-66-ST2 printer.

Table F-1 Service Tool Kit Items

Item	Description
Laptop or Desktop	With at least 1 available COM port (must be COM1 or COM2) Containing the following software: Download Utility™ Netplex Exit Tester* RS232 Exit Tester CommWrangler™
Download support tool	
Netplex test kit*	For testing Netplex printers
Hand tools	Power driver P1& P2 extended tips 9/32 nut driver Needle nose pliers Pocket screwdrivers: standard and Phillips (Phillips should be a small diameter shaft) Diagonal cutters 1 power strip
Thermal ticket stock	
Complete stock of repair parts	
Operators and Technicians Manual	MNL-000003

*For additional information on the Netplex interface, please contact International Game Technology.



Note: In most cases, use canned air to blow dust out of the printer.

Index

B

bezel, 3
descriptions, 32
LED control port, Netplex, 11
LED control port, RS232, 11
black mark indexed paper, 5

C

clearing a paper jam, 6
coiled cable connector, 9
configuration ticket, 6
controls, 2

D

dip switches
GEN2 Netplex, 15
GEN2 RS232, 23
Drawer Open sensor, 4

E

errors
Head Up, 4
Missing Black Index Mark, 4
Paper Jam, 4
Paper Out, 4
Print Head, 4
Temperature, 4
Voltage, 4

F

FEED button, 2, 5, 6
Firmware Upload Port
GEN2 Netplex, 14
GEN2 RS232, 22
Front Locking Bar, 10

G

GEN2 specifications, 24

H

Head Up error, 3, 4

I

indicators, 2

K

keypad status lights, 3

L

LEDs, 3
lid release lever, 2

M

mechanism release lever, 7
Missing Black Index Mark error, 3, 4

N

Netplex
bezel LED control port, 11
dip switches, GEN2, 15
firmware upload port, GEN2, 14
interface cable, GEN2, 12

P

paper
capacity, 1
feeding, 5
specifications, 26
Paper Jam
clearing, 6
error, 3, 4
Paper Low sensor, 3
Paper Out
error, 3, 4
sensor, 3
Paper Taken sensor, 3
Platen Engaged sensor, 4
ports
bezel LED control, Netplex, 11
bezel LED control, RS232, 11
GEN2 Netplex firmware upload, 14
GEN2 RS232 firmware upload, 22
Print Head
cleaning, 7
error, 3, 4

printer

- part numbers, 27
- removing, 9
- specifications, 24
- Printer Open sensor, 4

R

- release bar, 10
- removing the printer, 9
- RS232
 - bezel LED control port, 11
 - dip switches, GEN2, 23
 - firmware upload port, GEN2, 22
 - GEN2 adaptor cable, 19
 - GEN2 interface cable, 12 Pin, 16
 - GEN2 interface cable, 14 Pin, 18

S

- schematics, 34
- self test, 6

sensors, 3

- Drawer Open, 4
- Paper Low, 3
- Paper Out, 3
- Paper Taken, 3
- Platen Engaged, 4
- Printer Open, 4
- spares, part numbers, 27
- status
 - indicators, 2
 - LEDs, 3

T

- TCL Editor, 1
- Temperature error, 3, 4
- test ticket, 6
- ticket dimensional specifications, 26

V

- Voltage error, 3, 4

W

- warranty information, 1



FutureLogic, Inc.
425 East Colorado Street • Suite 100
Glendale, CA 91205 USA
Phone 818.244.4700 • Fax 818.244.4764
www.futurelogic-inc.com • info@futurelogic-inc.com